

MODEL DL2700 INSTALLATION INSTRUCTIONS

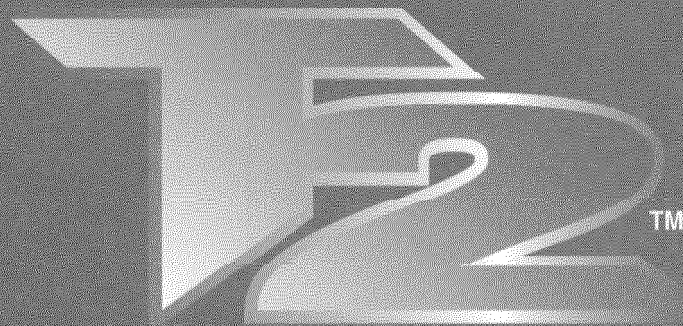

TRIOLOGY

**THE KEYLESS
ELECTRONIC
LOCKSET**

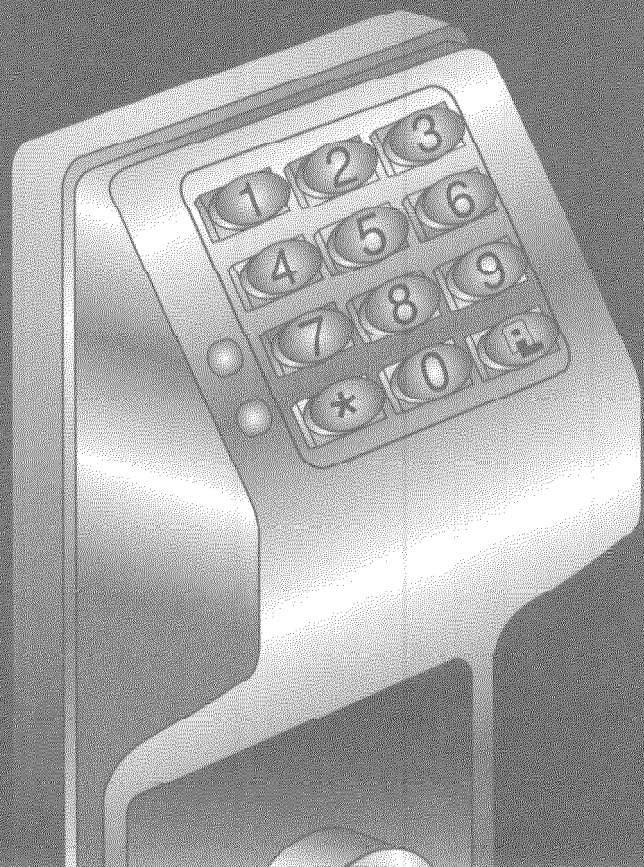

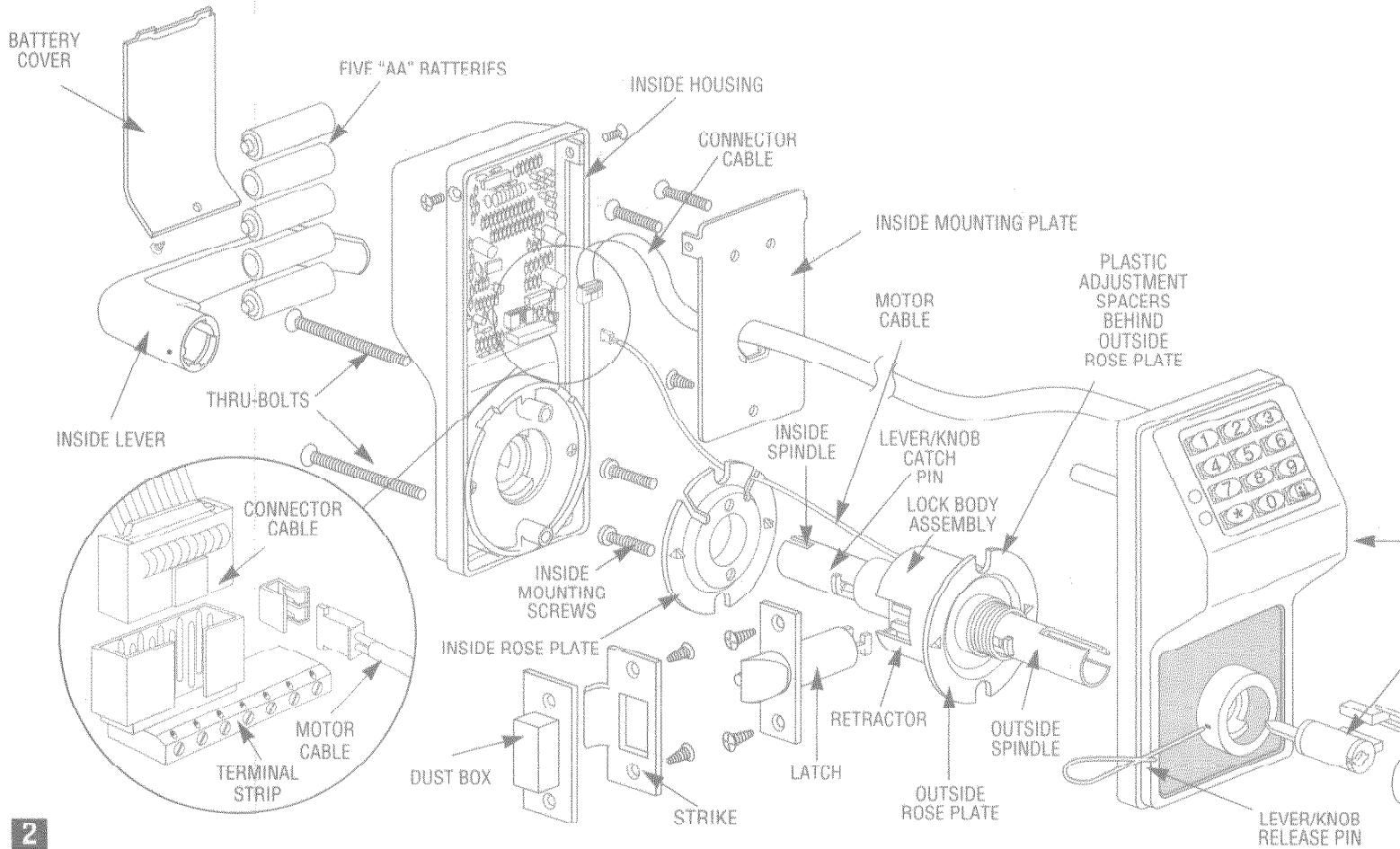

TRTM

TRILOGY

THE KEYLESS ELECTRONIC LOCKSET

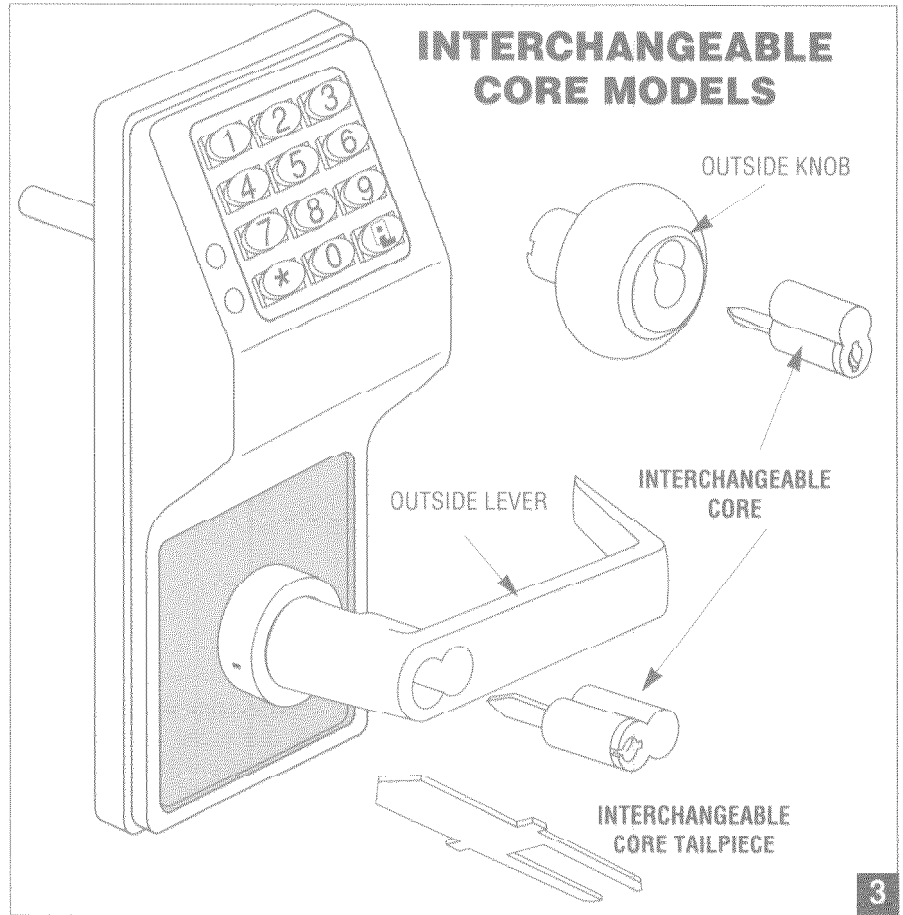
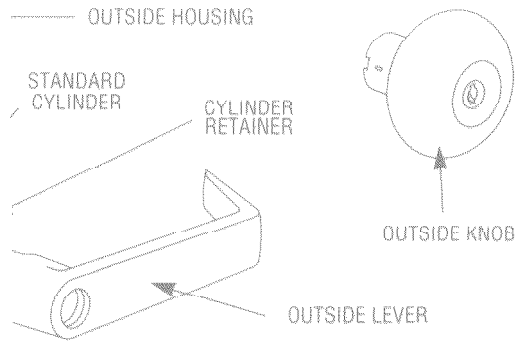

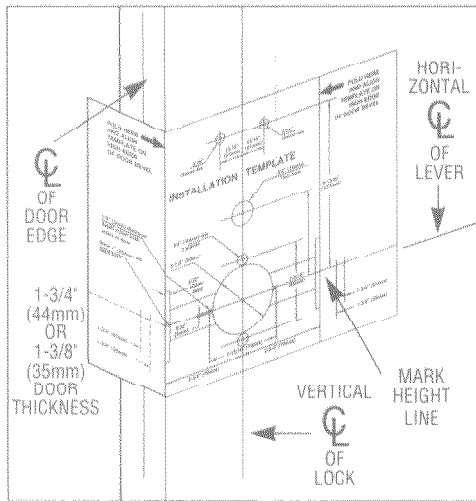

FIG. 1. DOOR PREPARATION:

1. Fold and place template on high edge of door at the recommended height from floor.
2. Mark hole centers on door and door edge.
3. Drill 3/8" Thru-Bolt holes first, then drill 2-1/8" hole.

FOR HARDWOOD DOORS:

Notch on both sides of 2-1/8" hole to accommodate mounting plate tabs.

FOR HOLLOW METAL DOORS require horizontal and vertical lock and latch case support.

Provided by door manufacturer.

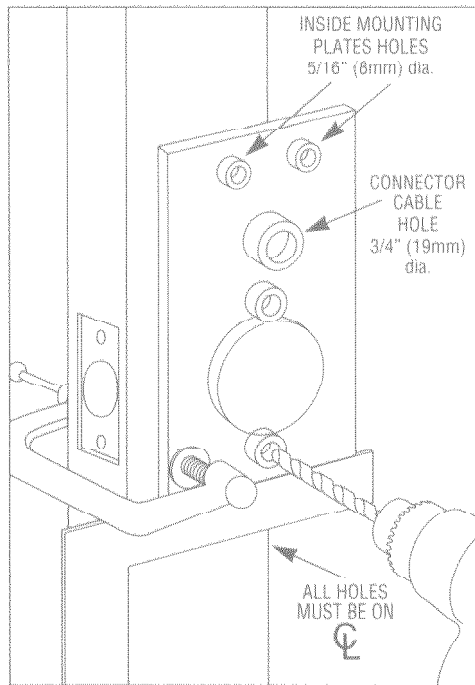

FIG. 2. ALARM LOCK INSTALLATION JIG

1. If 2-1/8" hole exists, use optional Alarm Lock Installation Jig to insure accurate locating and drilling of 3/8" Thru-Bolt holes.
2. For best results, align the Installation Jig to door with a square and clamp to door before drilling.

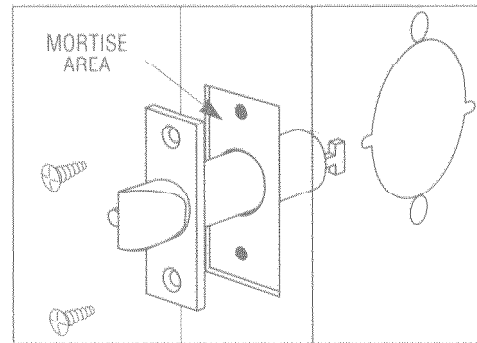

FIG. 3. LATCH INSTALLATION

1. Drill 1" diameter hole for latch. Mortise for latch front. Insert latch and fasten with two screws supplied.
- NOTE:** It is important that both 1" and 2-1/8" holes be on the same horizontal center line.

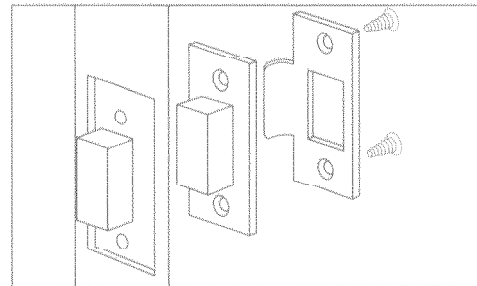

FIG. 4. STRIKE INSTALLATION

1. Align strike with latch.
2. Trace strike outline on door jamb.
3. Mortise jamb and install strike and dust box.

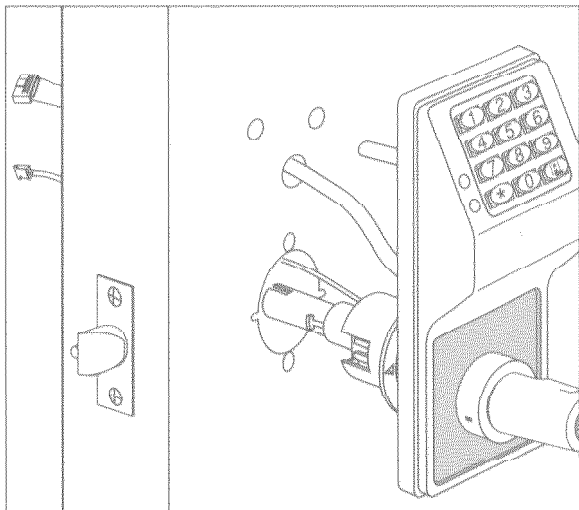

FIG. 5a. PREPARING LOCK FOR INSTALLATION

1. Insert the Lever/Knob Catch Pin into hole in the inside housing, depress Lever/Knob Catch and pull off lever/knob.
2. With the same pin depress the Lever/Knob Catch again to remove the inside housing.

**FIG. 5b. INSTALLING OUTSIDE TRIM ASSEMBLY
(Lever, Housing & Lock body)**

3. With inside lever & housing removed insert Motor wire through 2-1/8" hole & Connector wire through the 3/4" hole.
4. Insert Outside trim assembly into door and be sure to properly engage the lock body with the latch.
See "View from inside of door" diagram.
5. Latch Yoke must engage lock housing and tailpiece must engage Retractor.

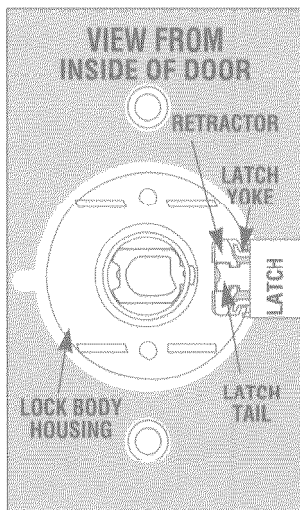

FIG. 7. HOW TO ADJUST DOOR THICKNESS:

Locks are factory assembled for 1-3/4" thick doors using 3 plastic spacers. **For other door thickness:**

1. Remove outside lever/knob, outside housing and unscrew outside rose plate.
- 2a. For 1-5/8" door remove one plastic spacer.
- 2b. For 1-7/8" door add one plastic spacer.
3. Screw mounting rose plate up to spacers.
4. Reassemble housing and lever/knob.

FOR OTHER DOOR THICKNESS CONSULT FACTORY

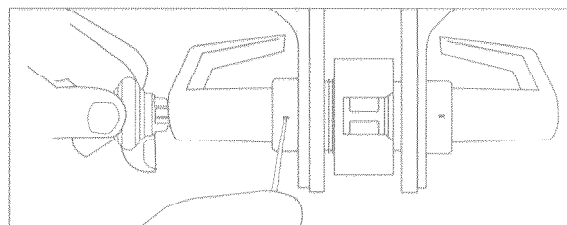
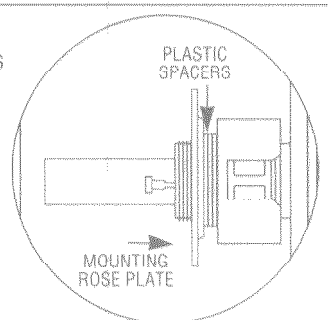

FIG. 6. TO REVERSE HANDING

With the inside Lever and Housing off:

1. Insert key into outside cylinder & turn 45°, depress Lever/Knob Catch & pull Lever/Knob off.
4. Rotate lock body 180°. Be sure Lever/knob catch faces the door edge. **If necessary depress Lever/Knob Catch & rotate outside spindle 180°.**
- 6a. Replace lever with key in cylinder at 45° angle and press on until Lever/Knob Catch engages.
- 6b. Replace knob with key in cylinder at 45° angle. Depress Lever/Knob Catch & push knob until Lever/Knob Catch engages.
7. Pull lever/knob to test for proper engagement.

FOR IC CORE MODELS SEE FIG. 10.

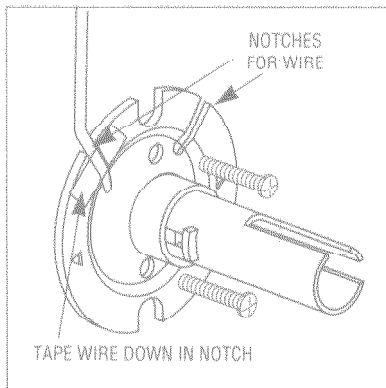

FIG. 8. INSTALLING INSIDE TRIM:

1. Place Inside Rose Plate over spindle and on door with the two notches facing up.
2. Insert Motor Wire through the Inside Rose plate and tape wire down in the notch to be sure the housing will not pinch or cut before fastening bolts.
3. Insert and fasten two mounting bolts.

IMPORTANT: The Motor Wire must come through either notch and lie within the notch without pinching or cutting the wire.

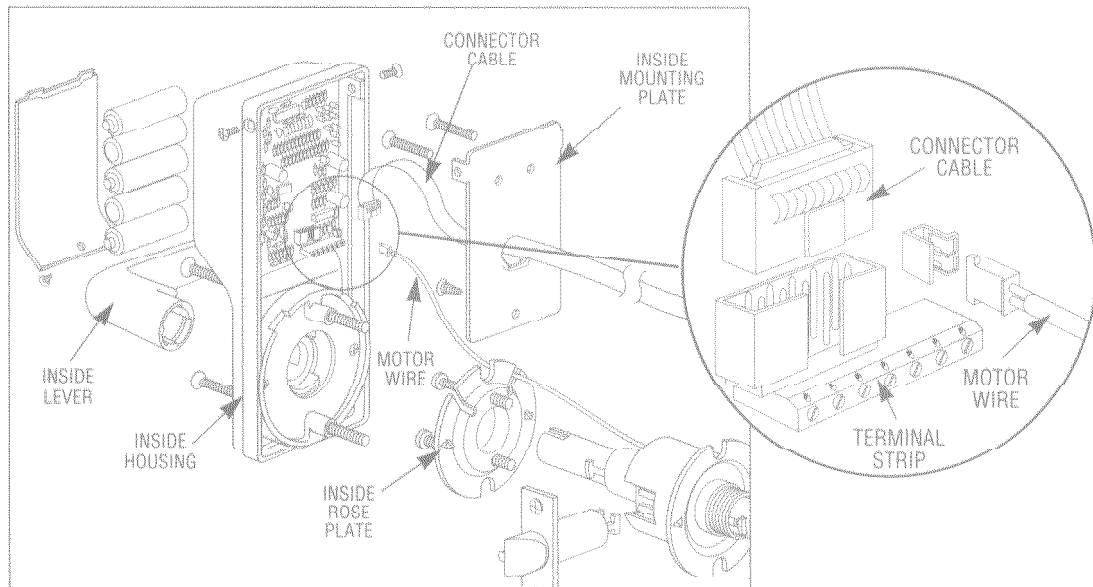

FIG. 9. INSTALLING INSIDE TRIM (Housing & Lever)

1. Pull the Connector Cable through the Inside Mounting Plate. Position plate on door and fasten with two 9/32"x1" long F.H.M.S. Fasten wood screw at bottom.
2. Plug the Connector Cable and the Motor Wire into the Housing. **Note: The connectors fit only one way (do not force them in). See inset.**
3. Place Inside Housing over the inside spindle, making sure that all wires are inside of the housing before tightening the two thru bolts.
4. Place Inside Lever/Knob on spindle and push on

until it engages with Lever/Knob Catch. Test lever/knob to be sure it is on securely and operates without binding.

5. Fasten two 6/32" x 3/8" long F.H.M.S. on side of housing.
6. Place 5 "AA" batteries into battery holder.

IMPORTANT: Batteries must be in proper position (+) and (-) in order for lock to properly operate.

TEST LEVERS/KNOBS & CYLINDERS FOR PROPER OPERATION

7. Insert battery cover and fasten with 4-40 x 1/4" F.H.M.S.
FOR PROGRAMMING, SEE PROGRAMMING INSTRUCTIONS.

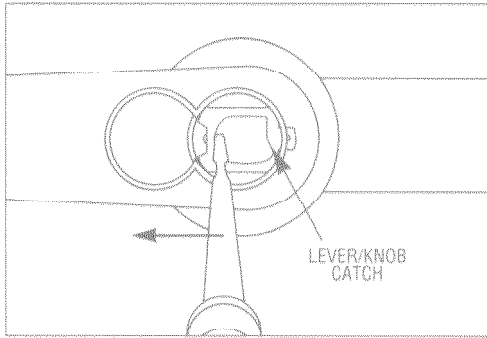

FIG. 10. TO REMOVE IC CORE LEVER/KNOB

- 1 With screwdriver inside lever/knob, push inside of Lever/Knob Catch to rear and pull off lever/knob.

TO INSERT IC CORE

2. Insert Alarm Lock tailpiece into cylinder.
3. With control key in cylinder turn clockwise.
4. Insert cylinder into lever/knob and turn key counterclockwise to lock in position.
5. Remove control key.

TO REMOVE CYLINDER, REVERSE PROCEDURE

For Handing and Door thickness, see Figs. 6 and 7.

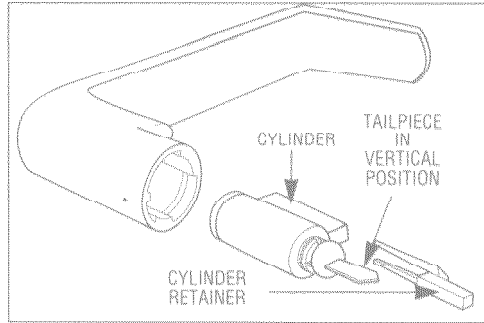

FIG. 11. CHANGING CYLINDER:

1. Remove outside lever/knob. See Fig. 6
2. Remove key from cylinder and pull plastic cylinder retainer from lever (using pliers), then remove cylinder.

TO REPLACE CYLINDER:

1. Tailpiece must be in vertical position in cylinder.
2. Insert cylinder in lever.
3. Press cylinder retainer into lever until flush with base of lever.

NOTE: USE TAILPIECE IN VERTICAL POSITION.

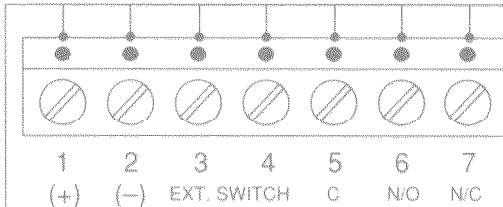

FIG. 12 TERMINAL BLOCK FUNCTIONS

1	2	3	4	5	6	7
+	-	Remote release	N/O	C	N/C	N/C
Optional D.C. Power Input 6 VDC		Pushbutton or switch			Remote output for monitoring or activation of external device	• 5-second changeover when correct code is entered

No additional power supply or electric strikes are required.

TROUBLESHOOTING

ELECTRONIC TROUBLE

SOLUTION

Lock will open with or without entering code.

Check for proper insertion of Motor Connector.

Lock will not accept new codes during programming.

Remove batteries, hold down any button until lock resets, then install batteries and start programming again.

Lock drains batteries quickly.

Check all wires for pinching or cutting. Check for water damage. If condition persists, consult factory.

Lock is completely dead.

Check batteries for proper polarity and check for cut wires.

Lock emits steady tone when any button is pressed.

Low battery signal - replace batteries.

MECHANICAL TROUBLE

SOLUTION

Lever/knob pulls off.

Lever/knob Catch not fully engaged. Lock is not centered on door. Door too thick.

Unable to assemble outside lever.

Key and tailpiece orientation is incorrect.

Latch will not fully retract.

Lock is not properly engaged with latch or mis-aligned. Lock is not centered on door.

Key binds in lock.

Lever/knob Catch not fully engaged. Lock is not centered on door. Check for proper tailpiece and proper orientation of tailpiece.

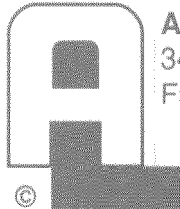

ALARM LOCK SYSTEMS, INC. is a division of the **NAPCO Security Group**
345 Bayview Avenue, Amityville, NY 11701 (516) 789-4871 1-800-ALA-LOCK
Fax: (516) 789-3383

© 1996, Alarm Lock "Trilogy®" is a registered trademark of Alarm Lock
"T2™" and "T2 Trilogy™" are trademarks of Alarm Lock



345 Bayview Avenue
 Amityville, New York 11701
 For Sales and Repairs 1-800-ALA-LOCK
 For Technical Service 1-800-645-9440
 © ALARM LOCK 2004

Trilogy

DL2700 Programming Instructions

OI209A 2/04

CONGRATULATIONS!

Your new Alarm Lock Trilogy electronic digital lock is a rugged entry lock of advanced design with several programmable features. Three security levels are provided: **Master** (can perform ALL functions), **Manager** (can perform MOST functions plus entry), and **Basic User** (entry only).



DL2700

The lock includes 100 User Codes (consisting of Managers and Basic Users), plus three "one-time entry" Service Codes. The Manager/Basic User Codes are organized similar to a grid--ten banks of ten Access Codes.

Take the time to read through this guide to familiarize yourself with the features and operations of the lock, and its quick and easy programming procedures.

Features

- 1 Master Code (all functions including entry)
- 10 Manager Codes (perform SOME programming functions plus entry)
- 90 Basic User Access Codes (Entry Only)
- 3 Service Codes ("One-Time Entry" Codes)
- Two User Disable Modes:
 - All User Codes Disabled Except Master Code
 - All User Codes in a Bank Disabled Except Manager Codes
- 30-Second Keypad Anti-Tamper Lockout: (Keypad Lockout After 3 Unsuccessful User Code Entries)
- Programmable Relay Functions: (Relay may be keypad programmed to energize on any keypress 0-9 or on unlock).

QUICK LOOKUP

Wiring	2
Quick Start	2
Testing Codes	3
Manager & User Location Worksheet	4
Manager & User Location Example.....	5
Programming Worksheet: Functions	6
Change Existing Master Code.....	7
Add/Change Manager Codes	7
Add/Change User Codes.....	7
Deleting Codes	7
Disable/Enable Users	7
Disable/Enable All	8
Code Location Function.....	8
Next Free Code Address Locator	8
Add/Delete Service Codes	9
Enable/Disable Passage Mode	9
Pass Time ("Door Unlock").....	9
Disable/Enable Groups.....	9
Disable/Enable Users in Bank	10
Keypress Sound Options.....	10
AUX Relay Functions	10
Lock Identifier	10
Audible and LED Indications	11
Battery Replacement.....	11
Erase All Programming	11
Limited Warranty	12

Wiring

See the Installation Instructions for more information.

Batteries:

Use only 1.5 volt Duracell Alkaline size-AA batteries.

External Power:

An external 7.5 VDC Power Source, capable of at least 100mA, must be used for operation without batteries in the lock. Use an external UL-Listed power supply provided with backup battery power and current limiting protection that is approved for the application.

BLACK = Negative, RED = Positive.

Aux Relay:

Aux Relay allows up to 300mA @ 60VDC Maximum. See page 10 for programming options for the Relay ("AUX Relay Functions").



BLUE = Common, YELLOW = N/O, GREEN = N/C.

Remote Switch Input (2 White Wires)

A remote momentary switch can be wired to allow access when activated. Wire a normally open push button switch to the two white wires. Press for one second to unlock the DL2700.

Quick Start

First Time Start Up









1. Unpack the lock from its factory packaging.
2. With the batteries disconnected, hold down the  key (or any numeric key) for 10 seconds and release.
3. Connect the batteries and--within 3 seconds--press and hold the  button. After hearing 6 beeps, release the  button. Wait 5 seconds for lock to re-lock (listen for 1 beep and red LED). This will clear the lock of all programmed data, and the lock is now ready to accept programming. **Note:** Failure to follow this exact procedure can result in erratic lock behavior.

Important Note: When entering any key sequence below, *do not pause more than 5 seconds between any key presses*--otherwise you must start again. (**Note:** If you wish, this 5-second delay between key presses can be extended--see *Pass Time* on page 9 after completing this section).

No other programming commands will be accepted until the Factory Master Code has been changed.

Change Factory Master Code



The Master Code is a "secret" code (entered at the keypad) that allows you to change ALL programming functions and options. Because all locks are manufactured identically (and leave the factory with the *same* Master Code), this "factory Master Code" is not very secret--and **MUST** be changed to your own personal Master Code to ensure security. A 5 digit Code is recommended.

1. Press the factory Master Code:     . A beep will sound and the lock will open.
2. Within 5 seconds, press   .
3. Within 5 seconds, enter a new Master Code. This new Master Code may consist of 3 to 5 digits*, however, the number selected determines the number required for all subsequent Manager and User Access Codes.
4. Press .
5. Re-enter the new Master Code again to validate. A 6-beep acknowledgement (with a red LED) will sound. Wait 5 seconds for lock to re-lock.
6. Test the new Master Code. Enter the new Master Code; a beep will sound and the lock will unlock. Now that the Master Code has been changed, there is no need to change it again (unless you want to).

For example, if you want your new Master Code to be "44444", press:

If you wish, write your new Master Code in the spaces provided:

        _____  _____

Write your new Master Code

(Repeat)

Continued

* Once the number of digits is selected, it cannot be changed unless all programming is erased and the Factory Default settings are re-loaded using the "Erase All Programming" procedure found on page 11.

Quick Start (cont'd)

Enter a Manager Code

Manager Codes are located at locations 00, 10, 20, 30, 40, 50, 60, 70, 80, and 90 (see grid on page 4). **Note:** New Manager Codes MUST use the same number of digits as the (new) Master Code. Enter as follows.

1. Press the (new) Master Code.
2. Press [press a Manager location i.e. 00, 10, 20, 30, 40, 50, 60, 70, 80, or 90] .
3. Press a new Manager Code using the same number of digits as the (new) Master Code. A 6-beep acknowledgement (with a red LED) will sound. Wait 5 seconds for lock to re-lock.
For example, if you want to add a Manager Code of "33333" in location 00,
[Press the (new) Master Code] .
4. If lock remains open, repeat from step 2; otherwise restart from step 1 for each new Manager Code.

Enter Basic User Access Codes

See the grid on page 4 for more information regarding User locations. You can choose to enter your User Codes in many possible locations, and in any order you wish. User Codes do not have programming privileges (entry only). Duplicate User Codes are not allowed.

1. Press the (new) Master Code or associated Manager Code.
2. Press [press a 2-digit location number] .
3. Press a new User Access Code using the same number of digits as the (new) Master Code. A six-beep acknowledgement (with a red LED) will sound. Wait 5 seconds for lock to re-lock. The new User Access Code is now entered in that location number.
For example, if you want to add a User Access Code of "22222" in User Number 01, press:
[(New) Master Code] .
4. If lock remains open, repeat from step 2; otherwise restart from step 1 for each new User Access Code.

Delete a User Access Code

The Master Code cannot be deleted. Manager Codes can only be deleted with the Master Code. If the location (User Number) of the Code is unknown, use the Code Location Function (page 8).

1. Press the (new) Master Code or Manager Code.
2. Press [press the 2-digit location number] . A six-beep acknowledgement (with a red LED) will sound. Wait 5 seconds for lock to re-lock. The User Access Code is now deleted.
For example, if you want to delete a User Access Code located in location 47, press:
[(New) Master/Manager Code] .
3. If lock remains open, repeat from step 2; otherwise restart from step 1 for each User Access Code you want to delete.

Testing Codes

VALID CODE - The Green LED will flash (with 1 beep) after a valid code is entered. The lock will unlock immediately and remain unlocked for about 5 seconds (this "unlocked" time is the "Pass Time"). To make the Pass Time longer or shorter, use the Pass Time Function on page 9. **Note:** While the lever or knob may be rotated at any time, the latch will not be engaged to unlock the door unless a valid User Access Code is entered at the keypad.

INVALID CODE - The Red LED will flash 5 times (with 5 beeps) after an invalid code is entered. (To quickly clear an invalid User Access Code, press and immediately re-enter the correct Code).

KEYPAD ANTI-TAMPER LOCKOUT - If 3 invalid User Access Codes are entered in succession, the lock will turn off for approximately 30 seconds to prevent tampering. The DL2700 will emit 2 beeps with a Red LED flash warning at the end of the anti-tamper period. The lock will exit Anti-Tamper mode in 30 seconds or upon activation of the Remote Switch Input (white wires). **Note:** The lock will go into Anti-Tamper after 3 unsuccessful Code entries *even if entered by different users and spaced apart in time*. Therefore, the lock may "appear" to go into Anti-Tamper Lockout *even after the entry of just one invalid User Access Code*.

Manager & User Location Worksheet

The DL2700 lock provides three "security levels": **Master** (can perform ALL functions), **Manager** (can perform SOME programming functions plus entry), and **Basic User** (entry only). In total, there are 104 "locations" inside the DL2700 lock: one Master Code, 10 Manager and 90 User Access Codes, and three "one-time entry" Service Codes. *Where the Access Code is located will determine its security level.* From the factory, all locations (except for the Master Code) are empty; each location can then be programmed to contain an Access Code, and these Access Codes enable Users to program and/or unlock the lock. As a visual aid, the 100 Manager/User Access Code locations are detailed in the grid below, with ten "Banks" (columns) of ten "Managers/Users" (rows). Each of the 100 squares in the grid is identified by a unique two-digit location (00) through (99). Notice that these two digits also specify its Bank (column) and Manager/User (row) location in the grid. Also notice that all Managers are in the top row, their locations all ending in a zero (locations 00, 10, 20, 30 and so on through 90). **Note:** Use the blank grid below as a **Programming Worksheet** for preparing all programming in advance. Store this worksheet in a safe place for future reference.

Each square represents a location inside the lock (excluding the Master Code and the 3 Service Codes). Each location can hold one "User Access Code" which can unlock the lock.

	BANK 0	BANK 1	BANK 2	BANK 3	BANK 4	BANK 5	BANK 6	BANK 7	BANK 8	BANK 9
MANAGERS →	MGR 00 -----	MGR 10 -----	MGR 20 -----	MGR 30 -----	MGR 40 -----	MGR 50 -----	MGR 60 -----	MGR 70 -----	MGR 80 -----	MGR 90 -----
USERS →	USER 01 -----	USER 11 -----	USER 21 -----	USER 31 -----	USER 41 -----	USER 51 -----	USER 61 -----	USER 71 -----	USER 81 -----	USER 91 -----
USERS →	USER 02 -----	USER 12 -----	USER 22 -----	USER 32 -----	USER 42 -----	USER 52 -----	USER 62 -----	USER 72 -----	USER 82 -----	USER 92 -----
USERS →	USER 03 -----	USER 13 -----	USER 23 -----	USER 33 -----	USER 43 -----	USER 53 -----	USER 63 -----	USER 73 -----	USER 83 -----	USER 93 -----
USERS →	USER 04 -----	USER 14 -----	USER 24 -----	USER 34 -----	USER 44 -----	USER 54 -----	USER 64 -----	USER 74 -----	USER 84 -----	USER 94 -----
USERS →	USER 05 -----	USER 15 -----	USER 25 -----	USER 35 -----	USER 45 -----	USER 55 -----	USER 65 -----	USER 75 -----	USER 85 -----	USER 95 -----
USERS →	USER 06 -----	USER 16 -----	USER 26 -----	USER 36 -----	USER 46 -----	USER 56 -----	USER 66 -----	USER 76 -----	USER 86 -----	USER 96 -----
USERS →	USER 07 -----	USER 17 -----	USER 27 -----	USER 37 -----	USER 47 -----	USER 57 -----	USER 67 -----	USER 77 -----	USER 87 -----	USER 97 -----
USERS →	USER 08 -----	USER 18 -----	USER 28 -----	USER 38 -----	USER 48 -----	USER 58 -----	USER 68 -----	USER 78 -----	USER 88 -----	USER 98 -----
USERS →	USER 09 -----	USER 19 -----	USER 29 -----	USER 39 -----	USER 49 -----	USER 59 -----	USER 69 -----	USER 79 -----	USER 89 -----	USER 99 -----

MASTER CODE

SERVICE CODE 1

SERVICE CODE 2

SERVICE CODE 3

LOCK DESCRIPTION _____

Manager & User Location Example

User Access Codes allow access only; *Manager Codes* allow more: Manager Codes have the ability to program and delete User Access Codes within that Manager's Bank (column). The DL2700 lock can hold up to 10 Manager Codes, one for each Bank (locations (00), (10), (20), (30), (40), (50), (60), (70), (80), (90)), and are all found at the top row of the grid below. **Note:** Only the Master Code can add or delete a Manager Code.

In addition, Managers not only possess programming abilities for User Access Codes residing in their own Bank, but also for *all higher Banks until the next programmed Manager Code appears*.

For example (see shaded grid below), if Manager Codes are programmed for locations (00) and (60), then the Manager in location (00) has control of the gray-shaded locations (00-09, 11-19, 21-29, 31-39, 41-49, and 51-59). The Manager in location (60) then has control over the black-shaded locations (61-69, 71-79, 81-89, and 91-99).

Note: If you wish to grant any Manager the ability to program any User, use the "Disable Groups" Function on page 9 (Enter the Master Code, then press     ).

	(BANK 0)	(BANK 1)	(BANK 2)	(BANK 3)	(BANK 4)	(BANK 5)	(BANK 6)	(BANK 7)	(BANK 8)	(BANK 9)
MANAGERS	MGR 00	MGR 10 (BLANK)	MGR 20 (BLANK)	MGR 30 (BLANK)	MGR 40 (BLANK)	MGR 50 (BLANK)	MGR 60	MGR 70 (BLANK)	MGR 80 (BLANK)	MGR 90 (BLANK)
→	→						→			
USERS	USER 01	USER 11	USER 21	USER 31	USER 41	USER 51	USER 61	USER 71	USER 81	USER 91
→										
USERS	USER 02	USER 12	USER 22	USER 32	USER 42	USER 52	USER 62	USER 72	USER 82	USER 92
→										
USERS	USER 03	USER 13	USER 23	USER 33	USER 43	USER 53	USER 63	USER 73	USER 83	USER 93
→										
USERS	USER 04	USER 14	USER 24	USER 34	USER 44	USER 54	USER 64	USER 74	USER 84	USER 94
→										
USERS	USER 05	USER 15	USER 25	USER 35	USER 45	USER 55	USER 65	USER 75	USER 85	USER 95
→										
USERS	USER 06	USER 16	USER 26	USER 36	USER 46	USER 56	USER 66	USER 76	USER 86	USER 96
→										
USERS	USER 07	USER 17	USER 27	USER 37	USER 47	USER 57	USER 67	USER 77	USER 87	USER 97
→										
USERS	USER 08	USER 18	USER 28	USER 38	USER 48	USER 58	USER 68	USER 78	USER 88	USER 98
→										
USERS	USER 09	USER 19	USER 29	USER 39	USER 49	USER 59	USER 69	USER 79	USER 89	USER 99
→										

Manager Location Example

Programming Worksheet: Functions

Directions: The Factory Master Code (1-2-3-4-5) must first be reprogrammed as a new Master Code before any other programming can take place. All new Access Codes must have the same number of digits as the new Master Code. Choose new Access Codes and write them in spaces provided (in pencil) before programming the lock. 6 beeps will usually be heard after an acceptable entry.





FUNCTION	PRESS THESE BUTTONS ON KEYPAD
Change Existing Master Code	[Enter Factory or Existing Master Code] [Enter New Master Code _____] [Re-enter New Master Code _____] [6 beeps = OK]
Add/Change Manager Codes (up to 10)	[Enter Master Code] [Enter 2-digit Manager Location __] [Enter new Manager Code _____] [6 beeps = OK]
Add/Change User Codes (up to 90)	Press Master or Manager Code [Enter 2-digit Location __] [Enter new User Code _____] [6 beeps = OK]
Deleting Manager & User Codes	Press Master or Manager Code [Enter Bank Number] [Enter User Number] *
Disable User Number	Press Master or Manager Code [Enter Bank Number] [Enter User Number]
Enable User Number	Press Master or Manager Code [Enter Bank Number] [Enter User Number]
Disable All	Press Master or Manager Code 9 5 5 (Reset with Function 944)
Enable All	Press Master or Manager Code 9 4 4
Disable Users Only	Press Master or Manager Code 9 5 0 (Reset with Function 944)
Code Location Function	Press Master or Manager Code 6 [Enter Code to be located]
Next Free Code--Address Locator	Press Master or Manager Code 7 [Responds with Bank # and User #]
Service Code 1	Press Master or Manager Code 3 0 1 [Enter new Service Code _____]
Service Code 2	Press Master or Manager Code 3 0 2 [Enter new Service Code _____]
Service Code 3	Press Master or Manager Code 3 0 3 [Enter new Service Code _____]
Clear Service Codes	Press Master or Manager Code 3 0 0
Enable Passage Mode	Press Master or Manager Code 4
Disable Passage Mode	Press Master or Manager Code 5
Pass Time ("Door Unlock")	Press Master Code 4 [Enter "02" - "20" seconds]
Enable Groups	Press Master Code 2 1 0
Disable Groups	Press Master Code 2 1 1
Disable Users In Bank	Press Master or Manager Code 8 5 [Enter Bank Number (0-9)]
Enable Users in Bank	Press Master or Manager Code 8 4 [Enter Bank Number (0-9)]
High Freq KP Feedback + Led	Press Master Code 2 2 0
Low Freq KP Feedback + Led	Press Master Code 2 2 1
Click! KP Feedback + Led	Press Master Code 2 2 2
Led Only	Press Master Code 2 2 3
Disable AUX Relay Function	Press Master Code 2 0 0
AUX Relay on any First Keypress (0-9)	Press Master Code 2 0 1
AUX Relay When Unlocked	Press Master Code 2 0 2
Lock Identifier	[Any Digit] [Any Digit] * [Listen for musical tones]

Note: Managers *do not* have the ability to add/delete/enable/disable Users outside their Bank, unless Groups are disabled.



Programming Functions



Change Existing Master Code*

For new locks, follow the "Quick Start" on page 2.

[_ _ _ _ _]    [_ _ _ _ _]  [_ _ _ _ _]
 Old (or "Factory") Master Code New Master Code* Confirm New Master Code*



Add/Change Manager Codes [_]

Follow the "Quick Start" on page 3. **Note:** You can also add/change the Manager Code in location 00 by entering the Master Code,    then the new Manager Code.

[_ _ _ _ _]  [_]   [_ _ _ _ _]
 Master Code** Manager Bank (Column) 0-9 User (Row) Always zero for Managers New Manager Code



Add/Change User Codes [_ _]

Follow the "Quick Start" on page 3.

[_ _ _ _ _]  [_ _]  [_ _ _ _ _]
 Master Code or Manager Code** Bank (Column) 0-9 User (Row) 1-9 New User Code

Deleting Manager & User Codes [_ _]

Follow the "Quick Start" on page 3.

[_ _ _ _ _]  [_ _]  
 Master or Manager Code** Manager Bank (Column) 0-9 User (Row) Always zero for Managers 0-9

Disable/Enable Users

Enter the Master Code to disable/enable any Manager or User, or enter a Manager Code to disable any User within the Manager's Bank.



Disable User Number [_ _ _ _ _]  [_ _]  (Allow system to relock)
 Master or Manager Code Bank/User Number

Enable User Number [_ _ _ _ _]  [_ _]  (Allow system to relock)
 Master or Manager Code Bank/User Number

* Once the number of digits is selected, it cannot be changed unless all programming is erased and the Factory Default settings are re-loaded (power must be removed and re-applied as per the "Erase All Programming" procedure found on page 11).
 ** Required only if DL2700 is locked.

Programming Functions (cont'd)





Add/Delete Service Codes

Service Codes are one-time-only Codes; once entered into the keypad, it is deleted. Use the same Code up to 3 times by programming all three Service Codes with the same Code. **Note:** Service Codes are lost if power is removed. To delete a single Service Code, press , enter Service Code number (301, 302 or 303), then press  .

Service Code 1 [_____]      [_____]
 Master/Manager Code** New Service Code



Service Code 2 [_____]      [_____]
 Master/Manager Code** New Service Code



Service Code 3 [_____]      [_____]
 Master/Manager Code** New Service Code

Delete All Service Codes [_____]     
 Master/Manager Code**

Enable/Disable Passage Mode



Allows passage without the need to enter a Code into the keypad.

Enable Passage Mode [_____]    ("Unlocked")
 Master or Manager Code**

Disable Passage Mode [_____]    ("Normal Operation")
 Master or Manager Code**

Pass Time ("Door Unlock")



The Pass Time is the time the lock stays unlocked after a valid Code entry. Use the function below to change the Pass Time from 02 to 20 seconds. The Pass Time factory default is 5 seconds. **NOTE:** The Pass Time will also determine the amount of time allowed between keypresses during programming.





Pass Time [_____]   [____] 
 Master Code** Pass Time

Disable/Enable Groups

Disable Groups: All Managers can program all User Access Codes, regardless of Bank.

Enable Groups: (Factory default) Managers restricted to controlling only those User Access Codes within their own Bank (column), and all following Banks until another Manager appears. User Access Codes in Banks outside of that Manager's Bank cannot be programmed.

Disable Groups [_____]     
 Master Code**





Enable Groups [_____]     
 Master Code**





** Required only if DL2700 is locked.

Programming Functions (cont'd)

Disable/Enable Users in Bank

Enter Bank number (0-9) to Enable/Disable all Users in Bank. Entering a disabled Code will result in an accented five beep error tone (indicating the User Access Code is valid but disabled).





Disable Users in Bank [_ _ _ _]    [_] 
Master/Manager Code** Bank Number





Enable Users in Bank [_ _ _ _]    [_] 
Master/Manager Code** Bank Number





Keypress Sound Options





The DL2700 is capable of emitting 1 of 4 possible keypress sounds:

- High Frequency Keypad Feedback + Led
- Low Frequency Keypad Feedback + Led
- "Click!" Keypad Feedback + Led
- Led Only

High Freq KP Keypress Sound + Led (Default) [_ _ _ _]     
Master Code**

Low Freq KP Keypress Sound + Led [_ _ _ _]     
Master Code**





Click! KP Keypress Sound + Led [_ _ _ _]     
Master Code**

Led Only [_ _ _ _]     
Master Code**

AUX Relay Functions

Program the functions below to activate the Auxiliary Relay on any numeric keypress (Function 201), or when the DL2700 is unlocked (Function 202). In either case the Aux Relay will be active for the duration programmed in Pass Time. See page 2 for information regarding the wiring of AUX leads.

Disable AUX Relay Function [_ _ _ _]     
Master Code**

AUX Relay on Any First Keypress (0-9) [_ _ _ _]     
Master Code**

AUX Relay When Unlocked [_ _ _ _]     
Master Code**

Lock Identifier

To aid in distinguishing your lock model from earlier Alarm Lock versions, your DL2700 model will respond to any two digits plus the star key by (1) lighting the green LED and (2) playing a musical scale of 8 notes.

Lock Identifier [_] [_] 
(Any Two Digits)

Audible and LED Indications

When a key is pressed, a beep will sound and a Red LED will flash. Other indications are:

- **Access Granted:** 1 beep and a Green LED flash. (When Pass Time ends, the DL2700 locks with a beep and a Red LED flash).
- **Invalid Code Entered:** 5 beeps and 5 Red LED flashes.
- **Disabled Code Entered:** 5 beeps (with extended first beep) and 5 Red LED flashes.
- **New Access Code Accepted:** 6 beeps and 6 Red LED flashes.
- **Programming Error:** 2 sets of 5 beeps and 5 Red LED flashes.
- **Return from Anti Tamper Lockout:** 2 beeps with a Red LED flash.
- **Low Battery:** High/Low sounder with flashing Red LED for 5 seconds. (See below to replace batteries).

Note: Keypress tones may be disabled using the      command (see Keypress Sound Options, page 10).

Battery Replacement

When the batteries are weak and a key is pressed, the lock will alert you by flashing the RED LED accompanied by a high/low sounder. The DL2700 uses five AA-size 1.5 volt alkaline batteries. The lock will function with weak batteries; however be sure to replace them as soon as possible.

If the DL2700 is ever without power for less than 1 minute (such as when replacing batteries), the DL2700 will continue its operation undisturbed--programming remains unaffected due to power provided by capacitors inside the lock. If the DL2700 is without power for greater than one minute, you have two choices--you can (1) retain the lock programming or (2) erase all programming. If you choose to erase all programming, the DL2700 will revert to its original factory default configuration ("out of the box").

CAUTION: Do not press any keys while batteries are disconnected unless you intend to erase all programming.

1. Remove the screw at the rear of the lock housing and remove the cover.
2. Remove battery pack and replace all 5 batteries quickly - within 1 minute.
3. Replace battery pack and cover. Tighten the cover screw to secure.

If you accidentally press a key (or fail to replace the batteries within 1 minute), use the **Retain Lock Programming** procedure below:



Retain Lock Programming

1. Re-install battery pack.
2. **Do not press any keys for 10 seconds.**

If you do not hear any beeps or if you hear 3 beeps (one per second), the previous lock programming is retained and the lock is now ready for use. If you test the DL2700 and find the lock programming is lost, you may erase all programming and return the DL2700 to its original factory settings, as described below.

Erase All Programming

Restore Factory Default (original settings that were set at the factory will be loaded).

1. Remove the battery pack, and with the batteries disconnected, press any numeric key for 10 seconds and release.
2. Connect the batteries and--within 3 seconds--press and hold . After hearing 6 additional beeps, release .

The DL2700 is now clear of all programmed data, and the lock is now ready to accept new programming. **Important:** If you do not hear these 6 beeps, you must start over at step 1.

 Failure to follow this exact procedure can result in erratic lock behavior.

Alarm Lock Limited Warranty

ALARM LOCK SYSTEMS, INC. (ALARM LOCK) warrants its products to be free from manufacturing defects in materials and workmanship for **24 months** following the date of manufacture. ALARM LOCK will, within said period, at its option, repair or replace any product failing to operate correctly without charge to the original purchaser or user.

This warranty shall not apply to any equipment, or any part thereof, which has been repaired by others, improperly installed, improperly used, abused, altered, damaged, subjected to acts of God, or on which any serial numbers have been altered, defaced or removed. Seller will not be responsible for any dismantling or reinstallation charges.

THERE ARE NO WARRANTIES, EXPRESS OR IMPLIED, WHICH EXTEND BEYOND THE DESCRIPTION ON THE FACE HEREOF. THERE IS NO EXPRESS OR IMPLIED WARRANTY OF MERCHANTABILITY OR A WARRANTY OF FITNESS FOR A PARTICULAR PURPOSE. ADDITIONALLY, THIS WARRANTY IS IN LIEU OF ALL OTHER OBLIGATIONS OR LIABILITIES ON THE PART OF ALARM LOCK.

Any action for breach of warranty, including but not limited to any implied warranty of merchantability, must be brought within the six months following the end of the warranty period. IN NO CASE SHALL ALARM LOCK BE LIABLE TO ANYONE FOR ANY CONSEQUENTIAL OR INCIDENTAL DAMAGES FOR BREACH OF THIS OR ANY OTHER WARRANTY, EXPRESS OR IMPLIED, EVEN IF THE LOSS OR DAMAGE IS CAUSED BY THE SELLER'S OWN NEGLIGENCE OR FAULT.

In case of defect, contact the security professional who installed and maintains your security system. In order to exercise the warranty, the product must be returned by the security professional, shipping costs prepaid and insured to ALARM LOCK. After repair or replacement, ALARM LOCK assumes the cost of returning products under warranty. ALARM LOCK shall have no obligation under this warranty, or otherwise, if the product has been repaired by others, improperly installed, improperly used, abused, altered, damaged, subjected to accident, nuisance, flood, fire or acts of God, or on which any serial numbers have been altered, defaced or removed. ALARM LOCK will not be responsible for any dismantling, reassembly or reinstallation charges.

This warranty contains the entire warranty. It is the sole warranty and any prior agreements or representations, whether oral or written, are either merged herein or are expressly cancelled. ALARM LOCK neither assumes, nor authorizes any other

person purporting to act on its behalf to modify, to change, or to assume for it, any other warranty or liability concerning its products.

In no event shall ALARM LOCK be liable for an amount in excess of ALARM LOCK's original selling price of the product, for any loss or damage, whether direct, indirect, incidental, consequential, or otherwise arising out of any failure of the product. Seller's warranty, as hereinabove set forth, shall not be enlarged, diminished or affected by and no obligation or liability shall arise or grow out of Seller's rendering of technical advice or service in connection with Buyer's order of the goods furnished hereunder.

ALARM LOCK RECOMMENDS THAT THE ENTIRE SYSTEM BE COMPLETELY TESTED WEEKLY.

Warning: Despite frequent testing, and due to, but not limited to, any or all of the following; criminal tampering, electrical or communications disruption, it is possible for the system to fail to perform as expected. ALARM LOCK does not represent that the product/system may not be compromised or circumvented; or that the product or system will prevent any personal injury or property loss by burglary, robbery, fire or otherwise; nor that the product or system will in all cases provide adequate warning or protection. A properly installed and maintained alarm may only reduce risk of burglary, robbery, fire or otherwise but it is not insurance or a guarantee that these events will not occur. CONSEQUENTLY, SELLER SHALL HAVE NO LIABILITY FOR ANY PERSONAL INJURY, PROPERTY DAMAGE, OR OTHER LOSS BASED ON A CLAIM THE PRODUCT FAILED TO GIVE WARNING. Therefore, the installer should in turn advise the consumer to take any and all precautions for his or her safety including, but not limited to, fleeing the premises and calling police or fire department, in order to mitigate the possibilities of harm and/or damage.

ALARM LOCK is not an insurer of either the property or safety of the user's family or employees, and limits its liability for any loss or damage including incidental or consequential damages to ALARM LOCK's original selling price of the product regardless of the cause of such loss or damage.

Some states do not allow limitations on how long an implied warranty lasts or do not allow the exclusion or limitation of incidental or consequential damages, or differentiate in their treatment of limitations of liability for ordinary or gross negligence, so the above limitations or exclusions may not apply to you. This Warranty gives you specific legal rights and you may also have other rights which vary from state to state.