

UniFLEX™ 45 Universal Electric Strike/Door Release

The SDC UniFLEX Electric Strike is Centerline Latch Entry* strike designed for use with Cylindrical and Mortise locksets with up to 3/4" (19mm) throw latchbolts.. The quality construction makes the 45 series ideal for high traffic applications. The compact low profile design enables quick and easy installation where jamb space is limited.





*Centerline Latch Entry: The latch must enter at the strike "Centerline" located exactly between the top and bottom of the strike faceplate. Refer to strike installation instructions and template to determine strike location prior to frame preparation for New and Retrofit installations. See SDC strike template and installation instructions for both retrofit and new installation details.

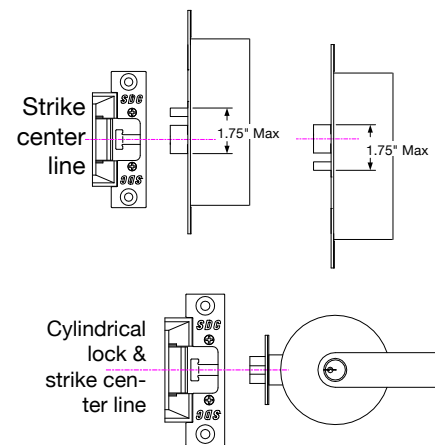
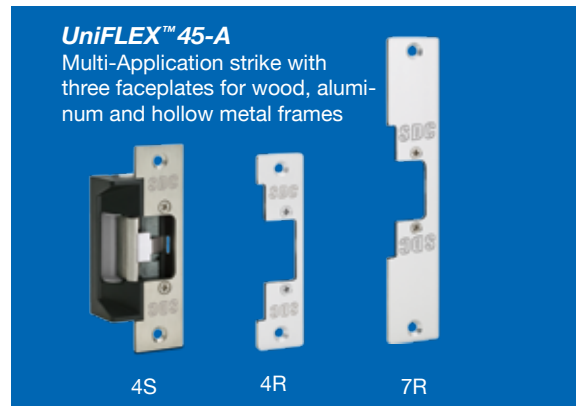

FEATURES

- Centerline Electric Strike
- 4 Interchangeable Application Faceplates
- Full Monitoring is Standard, Including: Latched and Unlatched Status, Keeper Closed and Deadlocked, or Unlocked
- Keeper Open Status Optional
- Reversible Failsafe/Failsecure, no disassembly
- 1/4" Horizontal Alignment Adjustment
- Plated Architectural Finishes Available
- For 5/8" latch or 3/4" latch with 1/8" door gap
- Latch position status standard
- Keeper closed & deadlocked/unlocked status standard
- Field selectable failsecure - failsafe
- Field selectable voltage
- 1/4" Horizontal alignment adjustment
- Low profile, 1-3/16" deep
- Plug-in wire connectors
- Mounting tabs
- Non-handed
- All stainless steel parts with durable die cast body for corrosion resistance
- Fewer moving parts for maximum life
- Stainless steel standard with square corner faceplate
- Aluminum standard with radius corner faceplate
- ANSI/ BHMA A156.31, Grade 2



MODEL	
 45-4S	4-7/8" x 1-1/4" square corner faceplate
 45-4R	4-7/8" x 1-1/4" radius corner faceplate
 45-6R	6-7/8" x 1-1/4" radius corner faceplate
 45-7R	7-15/16" x 1-7/16" radius corner faceplate
 45-A	Included: One 4-7/8" square corner faceplate One 4-7/8" radius corner faceplate One 7-15/16" radius corner faceplate

45F-4S Identical design to the 45 Strike, but made completely out of **Stainless Steel** so that it can withstand fire. Has been tested and rated to be considered a Grade 1 strike.

Call factory for faceplate availability with this strike or check our website SDCsecurity.com



SPECIFICATIONS

Electrical

Dual Voltage Coil 200/100mA @ 12/24V DC
140/70mA @ 12/24V AC

Latch Position Status (std) SPDT, Dry 3Amp @ 30V

Keeper Closed & Locked Status (std) SPDT, Dry 3Amp @ 30V

Keeper Open/Closed Status (optional) SPDT, Dry 3Amp @ 30V

Dimensions

45-4S / 45-4R	1-1/4" W x 4-7/8" H x 1-3/16" D
45-6R	1-1/4" W x 6-7/8" H x 1-3/16" D
45-7R	1-7/16" W x 7-15/16" H x 1-3/16" D

INSTRUCTIONS

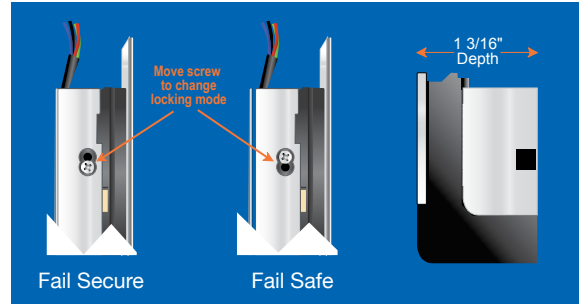

45 SERIES DIMENSIONS

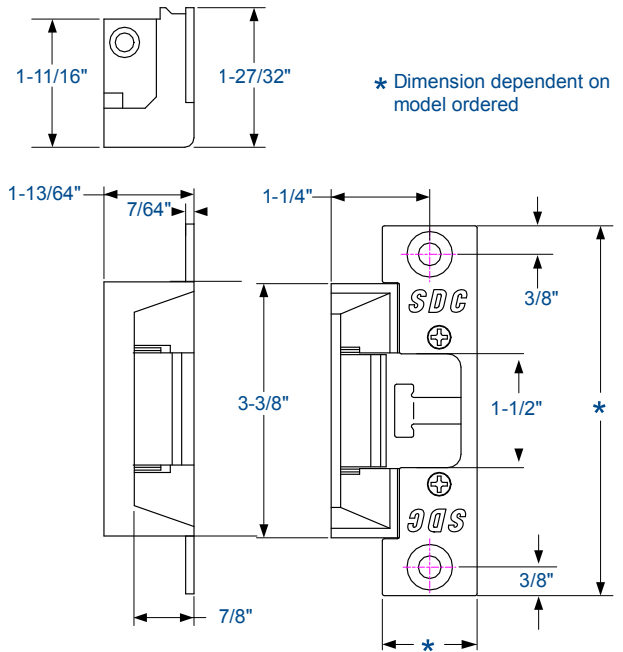

PRODUCT SKU SAMPLE: 45-4S U

HOW TO ORDER

1 | SPECIFY MODEL

- 45-4S** 4-7/8" x 1-1/4" square corner faceplate
- 45-4R** 4-7/8" x 1-1/4" radius corner faceplate
- 45-6R** 6-7/8" x 1-1/4" radius corner faceplate
- 45-7R** 7-15/16" x 1-7/16" radius corner faceplate
- 45-A** Included: One 4-7/8" square corner faceplate
One 4-7/8" radius corner faceplate
One 7-15/16" radius corner faceplate
- 45F-4S** Stainless Steel strike (fire rated)
with 4-7/8" x 1-1/4" square corner faceplate

Latch Position Status Standard

Keeper Closed and Deadlocked/Unlocked Status Standard

2 | SPECIFY FINISH

- U** 630 Dull Stainless Steel (standard with 45-4S)
- V** 628 Dull Aluminum (standard with 45-4R, 45-6R and 45-7R)
- Y** 335 Black Anodized
- D** 606 Dull Brass
- H** 613 Oil Rubbed Bronze

3 | SPECIFY OPTIONS

- K** Keeper open/closed status
- RMB** Buzzer 12/24V AC/DC operation

