



28466

4040XP/4041DA



Drop Plate

Installation Instructions

4040XP & 4041DA PUSH SIDE (TOP JAMB) DROP PLATE PERMITS 120° MAXIMUM OPENING

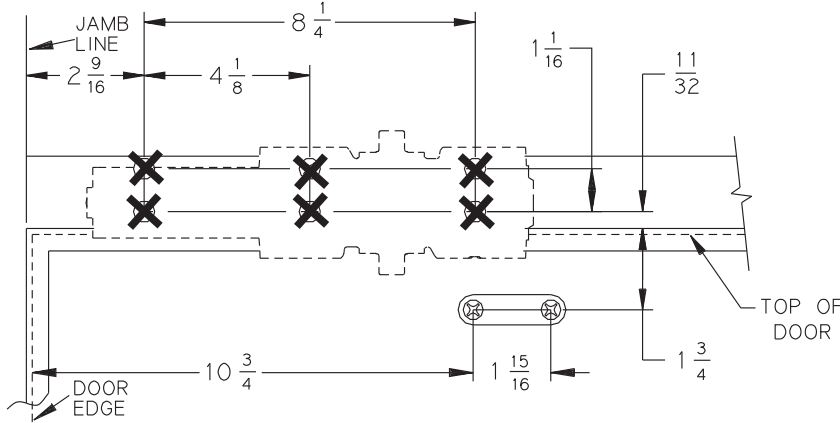

LEFT HAND DOOR SHOWN, RIGHT HAND OPPOSITE.

MAXIMUM REVEAL OF 2 9/16.
FOR REVEALS 2 5/8 - 4 13/16
SPECIFY LONG ROD.
FOR REVEALS 8"
SPECIFY EXTRA LONG ROD.

Locate drop plate & shoe from centerline of pivot or swing clear hinge pin when used.

PUSH SIDE MOUNT ON: 4040-18TJ DROP PLATE

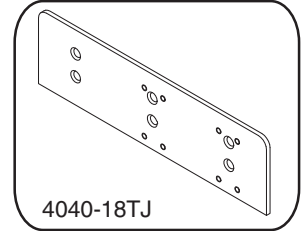

4040-18TJ

4040XP & 4041DA PUSH SIDE (TOP JAMB) DROP PLATE PERMITS 120° MAXIMUM OPENING

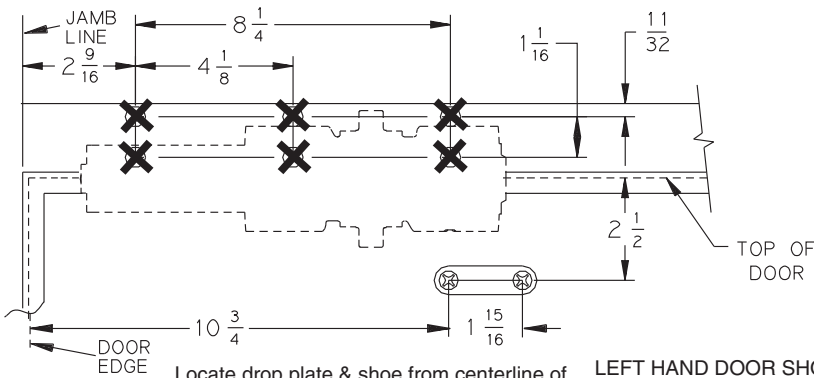

Locate drop plate & shoe from centerline of pivot or swing clear hinge pin when used.

LEFT HAND DOOR SHOWN, RIGHT HAND OPPOSITE.

PUSH SIDE MOUNT ON: 4040-18G DROP PLATE

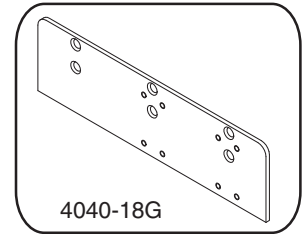

4040-18G

MAXIMUM REVEAL OF 2 9/16.
FOR REVEALS 2 5/8 - 4 13/16
SPECIFY LONG ROD.
FOR REVEALS 8"
SPECIFY EXTRA LONG ROD.

4040XP & 4041DA PULL SIDE (DOOR JAMB) DROP PLATE PERMITS 120° MAXIMUM OPENING

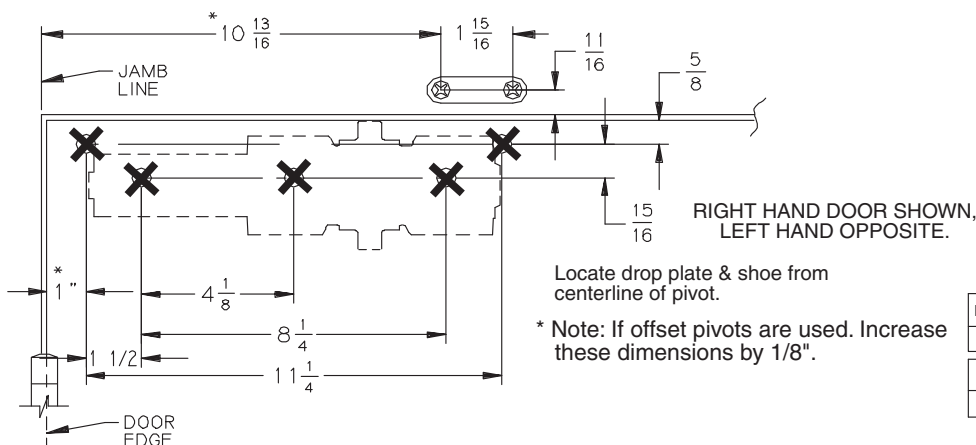

Locate drop plate & shoe from centerline of pivot.

* Note: If offset pivots are used. Increase these dimensions by 1/8".

PULL SIDE MOUNT ON: 4040-18 DROP PLATE

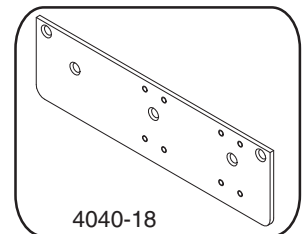

4040-18

INCH	11/32	5/8	11/16	15/16	1	1 1/16	1 1/2	1 3/4
M.M.	9	16	17	24	25	27	38	44
INCH	1 15/16	2 1/2	2 9/16	4 1/8	8 1/4	10 3/4	10 13/16	11 1/4
M.M.	49	64	65	105	210	273	275	286

4040XP PA PUSH SIDE (DOOR MOUNT) DROP PLATE PERMITS 180° MAX. OPENING, BUTT SIZE 5x5 MAX.

**PUSH SIDE MOUNT ON:
4040-18PA DROP PLATE**

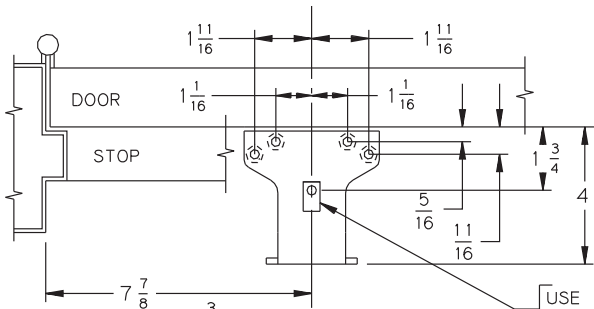

IMPORTANT
Before installing closer, turn backcheck selector valve (found on opposite side of closer from regulating screw side) all the way in (clockwise).

IMPORTANT

USE SPACER BLOCK PROVIDED FOR FIFTH SCREW. 1/2 OR 5/8

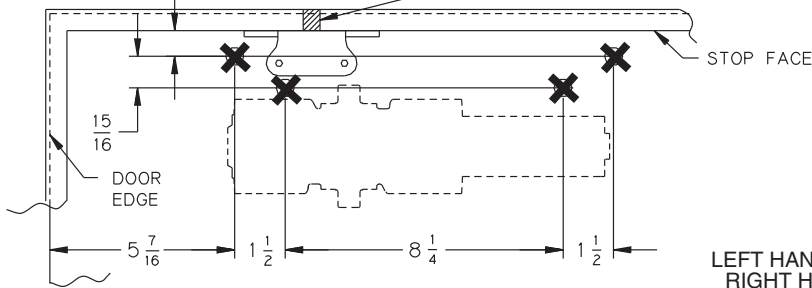

Locate drop plate & shoe from centerline of pivot or swing clear hinge pin when used.

LEFT HAND DOOR SHOWN,
RIGHT HAND OPPOSITE.

4041PA DELAY PUSH SIDE (DOOR MOUNT) DROP PLATE

**PUSH SIDE MOUNT ON:
4040-18PA DROP PLATE**

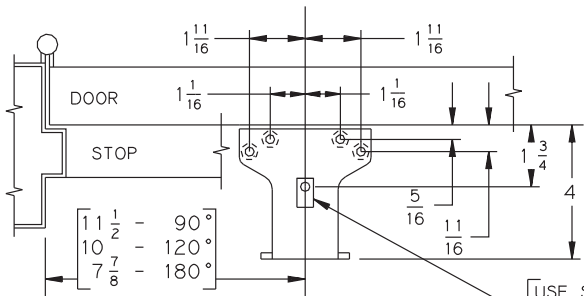

IMPORTANT
Before installing closer, turn backcheck selector valve (found on opposite side of closer from regulating screw side) all the way in (clockwise).

IMPORTANT

USE SPACER BLOCK PROVIDED FOR FIFTH SCREW. 1/2 OR 5/8

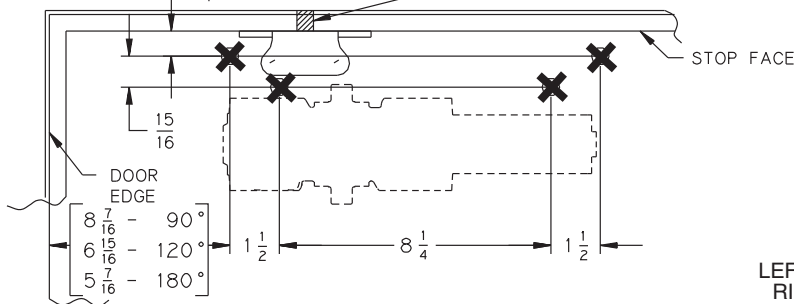

Locate drop plate & shoe from centerline of pivot or swing clear hinge pin when used.

LEFT HAND DOOR SHOWN,
RIGHT HAND OPPOSITE.

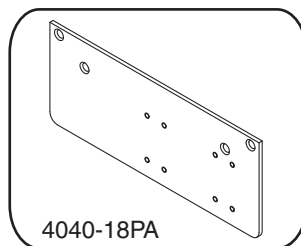

INCH	5/16	11/16	3/4	15/16	1 1/16	1 1/2	1 11/16	1 3/4
M.M.	8	17	19	24	27	38	43	44
INCH	4	5 7/16	6 15/16	7 7/8	8 1/4	8 7/16	10	11 1/2
M.M.	102	138	176	200	210	214	254	292

**4040XP CUSH PUSH SIDE (DOOR MOUNT) DROP PLATE
PERMITS 110° MAX. OPENING, MIN. TOP RAIL 2 1/2".**

**PUSH SIDE MOUNT ON:
4040-18PA DROP PLATE**

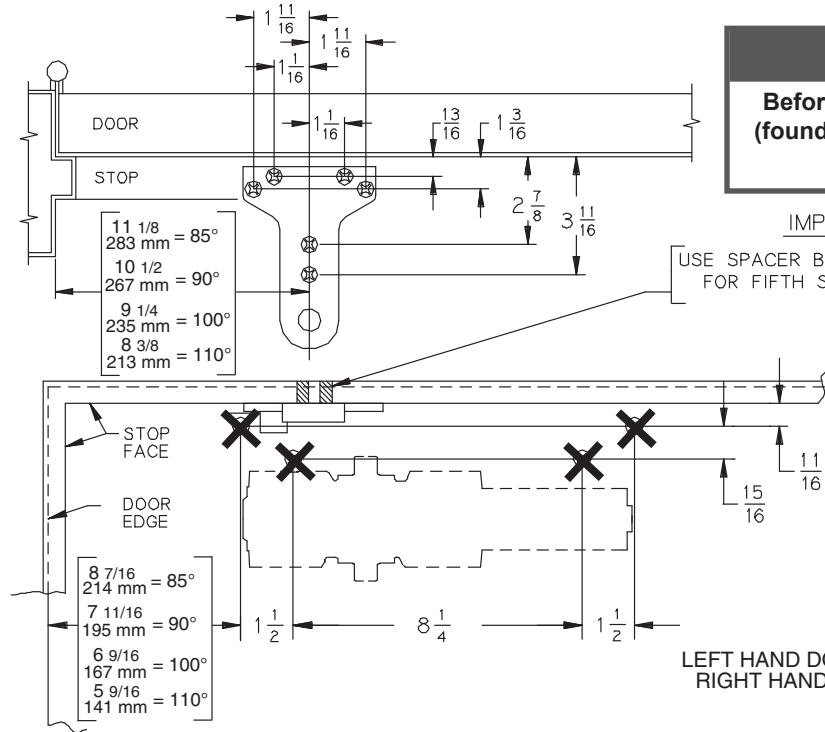

IMPORTANT
Before installing closer, turn backcheck selector valve (found on opposite side of closer from regulating screw side) all the way in (clockwise).

IMPORTANT
USE SPACER BLOCK PROVIDED FOR FIFTH SCREW. 1/2 OR 5/8

Locate drop plate & shoe from centerline of pivot or swing clear hinge pin when used.

LEFT HAND DOOR SHOWN, RIGHT HAND OPPOSITE.

**4040XP EDA PUSH SIDE (DOOR MOUNT) DROP PLATE
PERMITS 180° MAX. OPENING, MIN. TOP RAIL 2 1/2".**

**PUSH SIDE MOUNT ON:
4040-18PA DROP PLATE**

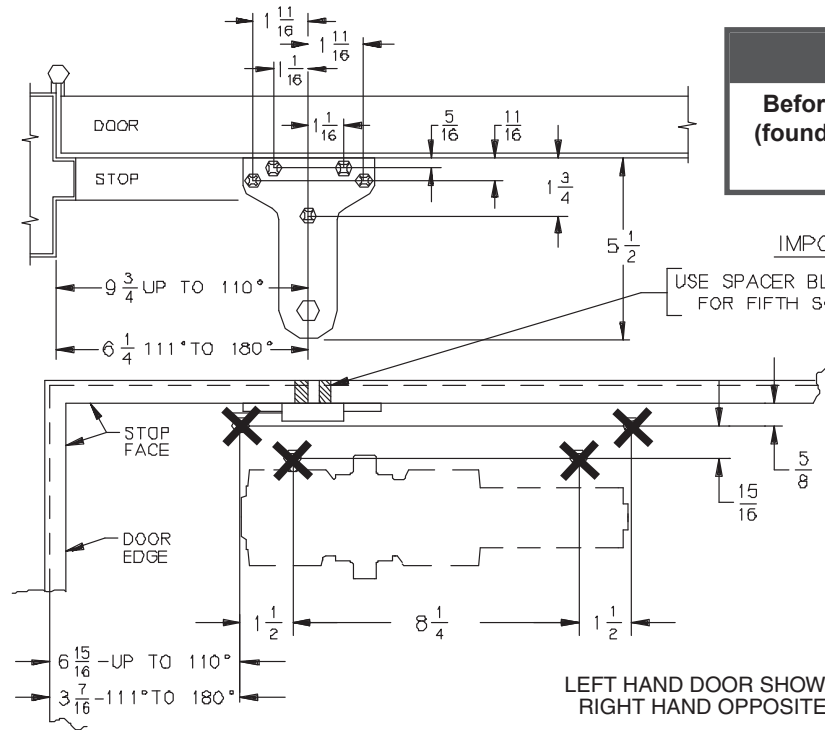

IMPORTANT
Before installing closer, turn backcheck selector valve (found on opposite side of closer from regulating screw side) all the way in (clockwise).

IMPORTANT
USE SPACER BLOCK PROVIDED FOR FIFTH SCREW. 1/2 OR 5/8

Locate drop plate & shoe from centerline of pivot or swing clear hinge pin when used.

LEFT HAND DOOR SHOWN, RIGHT HAND OPPOSITE.

INCH	5/16	1/2	5/8	11/16	13/16	15/16	1 1/16	1 3/16	1 1/2
M.M.	8	13	16	17	21	24	27	30	38
INCH	1 11/16	1 3/4	2 7/8	3 7/16	3 11/16	5 1/2	5 7/8	6 1/4	6 11/16
M.M.	43	44	73	87	94	140	149	159	170
INCH	6 15/16	8 1/16	8 1/4	8 9/16	8 5/8	9 1/2	9 3/4	10 13/16	11 1/4
M.M.	176	205	210	217	219	241	248	275	286

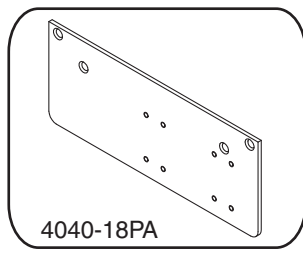

4040-18PA

4040XPT PULL SIDE (DOOR MOUNT) DROP PLATE
PERMITS 120° MAXIMUM OPENING, MIN. TOP RAIL 1 13/16"

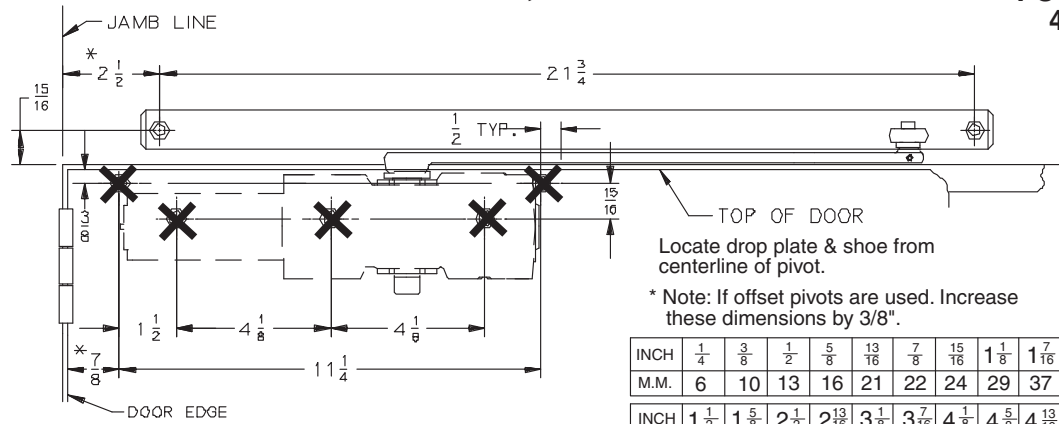

* Note: If offset pivots are used. Increase these dimensions by 3/8".

INCH	1/4	3/8	1/2	5/8	13/16	7/8	15/16	1 1/8	1 7/16
M.M.	6	10	13	16	21	22	24	29	37
INCH	1 1/2	1 5/8	2 1/2	2 13/16	3 1/8	3 7/16	4 1/8	4 5/8	4 13/16
M.M.	38	41	64	71	79	87	105	117	122
INCH	5 3/8	5 5/8	9 3/4	11 1/4	21 3/4				
M.M.	137	143	248	286	553				

RIGHT HAND DOOR SHOWN, LEFT HAND OPPOSITE.

**PUSH SIDE MOUNT ON:
4040-18 DROP PLATE**

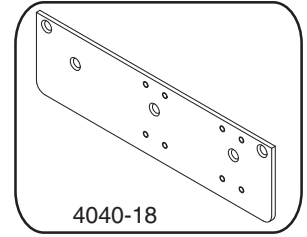

4040-18

4040XPT PULL SIDE (TOP JAMB) DROP PLATE
PERMITS 180° MAXIMUM OPENING, MIN. FACE OF FRAME 1 3/4"

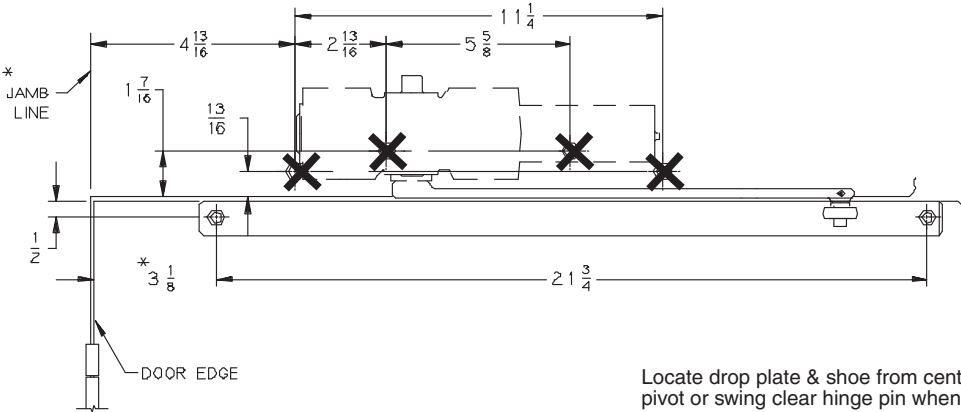

Locate drop plate & shoe from centerline of pivot or swing clear hinge pin when used.

RIGHT HAND DOOR SHOWN, LEFT HAND OPPOSITE.

**PUSH SIDE MOUNT ON:
4040T-18 DROP PLATE**

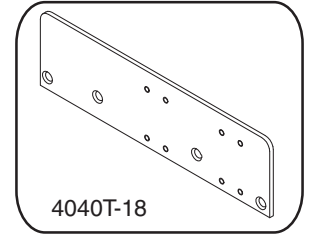

4040T-18

4040XPT PUSH SIDE (DOOR MOUNT) DROP PLATE
PERMITS 120° MAXIMUM OPENING, MIN. TOP RAIL 2 1/4"

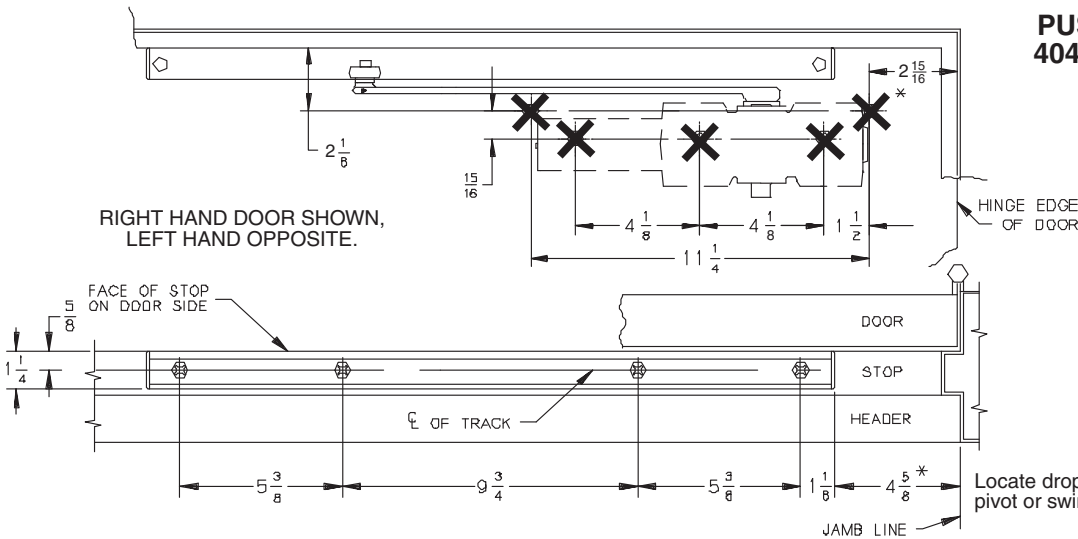

Locate drop plate & shoe from centerline of pivot or swing clear hinge pin when used.

**PUSH SIDE MOUNT ON:
4040-18PA DROP PLATE**

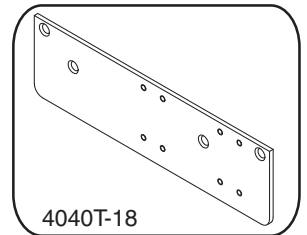

4040T-18