



The 1600 Series is also available in a **Complete One Box Solution**

1600 Series

The dynamic, low profile solution for latchbolts and deadbolts

Shown with 1N faceplate

The HES 1600 Series electric strike accommodates up to a 1" deadbolt with enhanced vertical cavity spacing and will accommodate every brand of cylindrical or mortise lock designed to work with a 4-7/8" strike plate.

The HES 1500 and 1600 Series Electric Strikes set a new standard in the industry by offering dynamic integrated adjustability and field configurable options compatible with any cylindrical or mortise lock. The modular design of the platform makes stocking and installing easier with interchangeable faceplates and accessories. For the first time, the aesthetics of an electric strike are complementary to other surrounding door hardware and blend in with the opening due to the fully finished design, available in seven finishes.

Specifications

- UL 10C fire-rated, 3 hour single door (fail secure only)
- UL 10C fire-rated, 1-1/2 hour double door
- CAN/ULC-S104 fire door conformant
- ANSI/SDI A250.13 windstorm resistant
- ANSI-ASTM E330
- Florida Building Code approved TAS 201, 202, 203
- UL 1034 burglary-resistant listed and suitable for outdoor use
- UL 294 (6th Edition) listed
- ANSI/BHMA A156.31, Grade 1

- California State Fire Marshal listed
- NFPA-252 fire door conformant
- ASTM-E152 fire door conformant
- RoHS compliant
- Patent pending
- PoE friendly

Frame Application

- Metal
- Wood

Electrical (continuous duty)

- DC continuous duty, AC intermittent duty
- 0.24 Amps at 12VDC/VAC
- 0.12 Amps at 24VDC/VAC

1600 Models

1600	Universal electric strike	Faceplate option kits ordered separately
1600CS	Complete electric strike	Includes the 1LB faceplate kit for latchbolts and 1DB faceplate kit for deadbolts
1600CLB	Complete electric strike	Includes the 1LB faceplate kit for latchbolts
1600CDB	Complete electric strike	Includes the 1DB faceplate kit for deadbolts

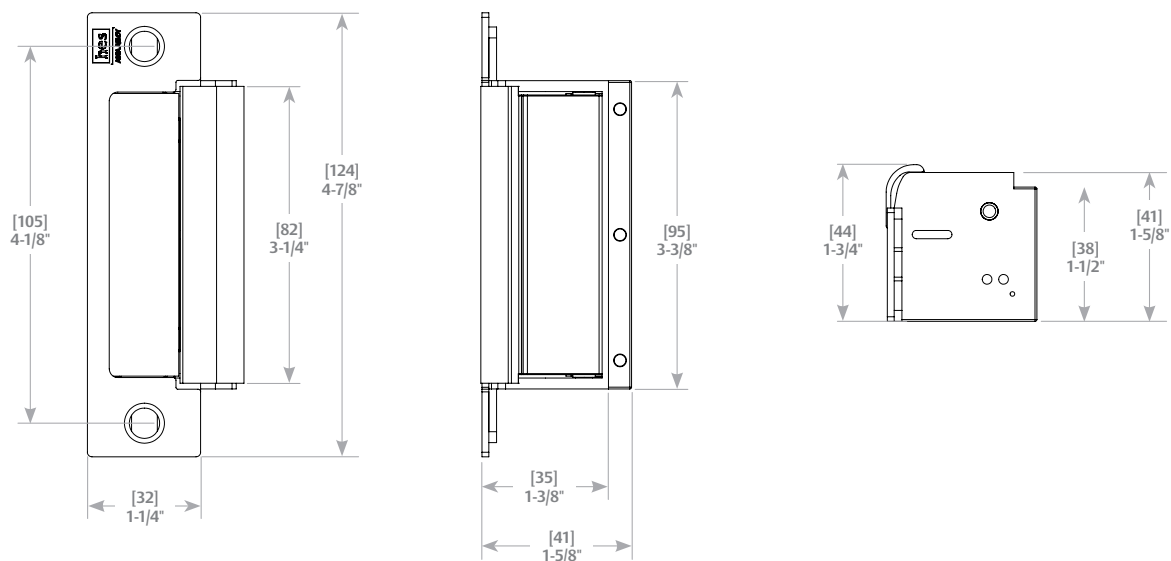

Standard Features

- Stainless steel construction
- Tamper-resistant
- Dual-voltage 12/24 VDC continuous duty
- Static strength 1,500 lbs
- Dynamic strength 70 ft-lbs
- Endurance 1,000,000 cycles
- Field selectable fail safe/fail secure
- Non-handed
- Interchangeable faceplates and accessories
- Field replaceable components
- Fully finished faceplate, keeper, case and trim
- Field adjustable integrated shim
- ElectroLynx® connectors
- 5 year limited warranty

Optional Features

- **LM** » Lock monitor
- **DLM** » Dual lock monitors
- **LMS** » Lock monitor and strike monitor
- **DLMS** » Dual lock monitors and strike monitor

Accessories

- **157** » Torx screws
- **HES-CUT-MTK** » Metal template kit
- **1600-104-xxx** » Lip extension trim adapter (finish to match)
- **1600-106-xxx** » 1006 adapter and trim enhancer kit (finish to match)
- **OPT-1SRK** » Spring replacement kit
- **OPT-1LM** » Single lock monitor
- **OPT-1DLM** » Dual lock monitors
- **MOD-1SOL** » Solenoid replacement module

Finishes

- **605** » Bright brass
- **606** » Satin brass
- **612** » Satin bronze
- **613E** » Dark oxidized satin bronze
- **629** » Bright stainless steel
- **630** » Satin stainless steel
- **BLK** » Black suede



1500C Complete Electric Strike

For all cylindrical and mortise locksets with 3/4" latchbolt

The **1500C** includes a 1500 electric strike body and the 1LB faceplate kit for latchbolts.

Compatible Locksets:

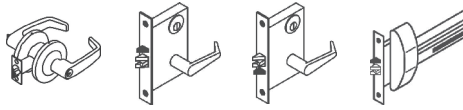

1600CLB Complete for Latchbolt Locks

The Complete One Box Solution for all cylindrical and mortise locksets

The **1600CLB** includes a 1600 electric strike body and the 1LB faceplate kit for latchbolts.

Compatible Locksets:

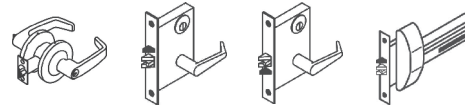

1600CS Complete Electric Strike

The Complete One Box Solution for all cylindrical and mortise locksets, with or without a 1" deadbolt

The **1600CS** includes a 1600 electric strike body, the 1LB faceplate kit for latchbolts and the 1DB faceplate kit for deadbolts.

Compatible Locksets:

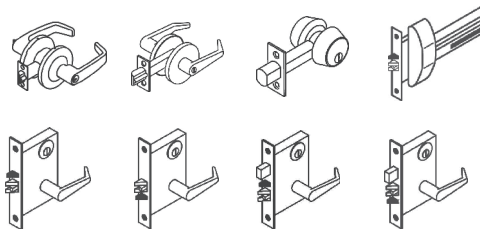

1600CDB Complete for Deadbolt Locks

The Complete One Box Solution for all locksets with a 1" deadbolt

The **1600CDB** includes a 1600 electric strike body and the 1DB faceplate kit for deadbolts.

Compatible Locksets:

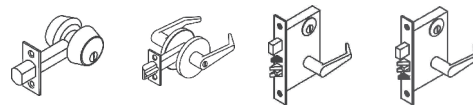

1500 & 1600 Series Faceplate Options



Operation: After releasing the latchbolt, the keeper returns to the locked position



4-7/8" x 1-1/4"

1LB Option

The Latchbolt Solution: Includes the hardware to accommodate every cylindrical and mortise lock up to a 3/4" latchbolt. For metal frame applications.

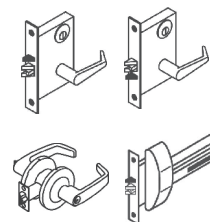

Operation: After releasing the latchbolt, the keeper returns to the locked position



9" x 1-3/8"

1LB-2 Option

The Latchbolt Solution: Includes the hardware to accommodate every cylindrical and mortise lock up to a 3/4" latchbolt. For wood frame applications.

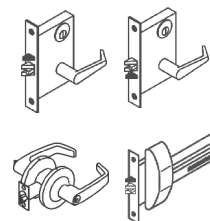

Operation: This deadbolt solution offers two modes of functionality; night latch, lockout, and normally extended deadbolt. (Functional operation modes described below.)



4-7/8" x 1-1/4"

1DB Option (1600 Only)

The Deadbolt Solution: Includes all hardware to retain, and release all mortise locks, and tubular deadbolts up to a 1" latchbolt. For metal frame applications.

Mode 1: Night latch function. The deadbolt is retracted during traffic hours. The latchbolt is released by the keeper and keeper returns to the locked position.

Mode 2: Lockout function. The electric strike will not release if the deadbolt is extended.

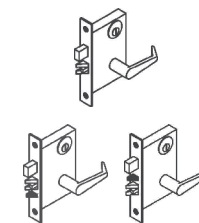

Operation: This deadbolt solution offers two modes of functionality; night latch, lockout, and normally extended deadbolt. (Functional operation modes described below.)



9" x 1-3/8"

1DB-2 Option (1600 Only)

The Deadbolt Solution: Includes all hardware to retain, and release all mortise locks, and tubular deadbolts up to a 1" latchbolt. For wood frame applications.

Mode 1: Night latch function. The deadbolt is retracted during traffic hours. The latchbolt is released by the keeper and keeper returns to the locked position.

Mode 2: Lockout function. The electric strike will not release if the deadbolt is extended.

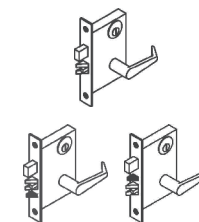

1500 & 1600 Series Faceplate Dimensions

1J
Faceplate Option

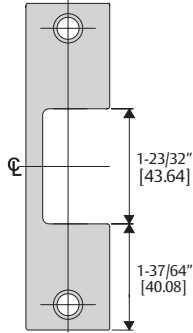

1K
Faceplate Option

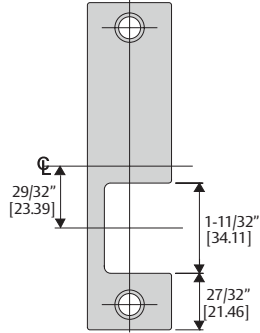

1KD
Faceplate Option

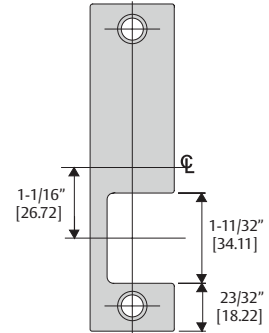

1KM
Faceplate Option

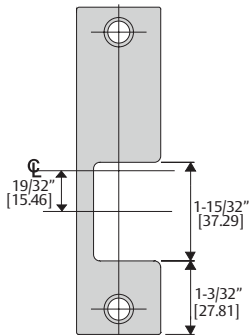

1N
Faceplate Option

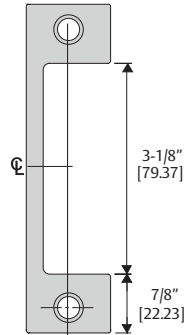

1ND
Faceplate Option

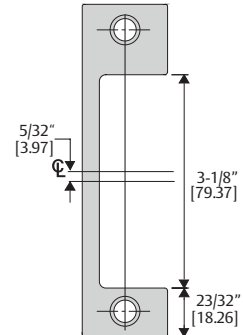

1NM
Faceplate Option

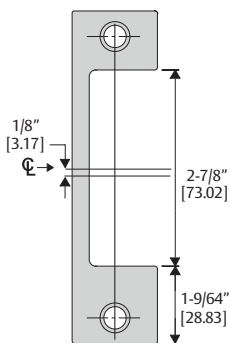

1NTD
Faceplate Option

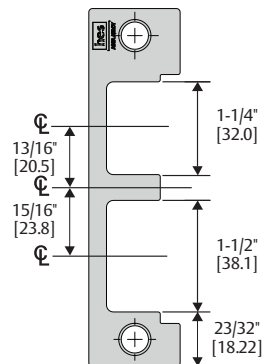

1500 & 1600 Series Faceplate Dimensions

1J-2
Faceplate Option

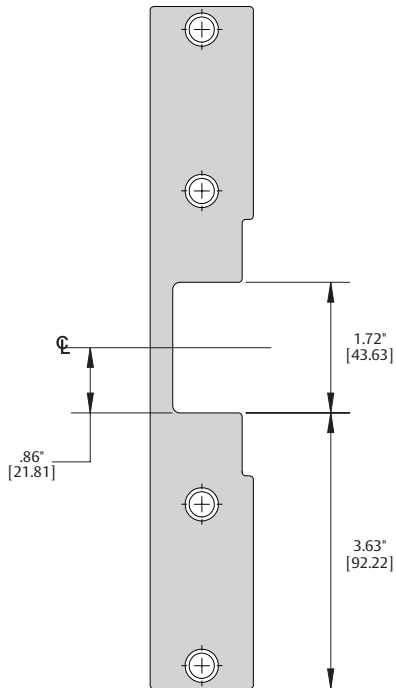

1KM-2
Faceplate Option

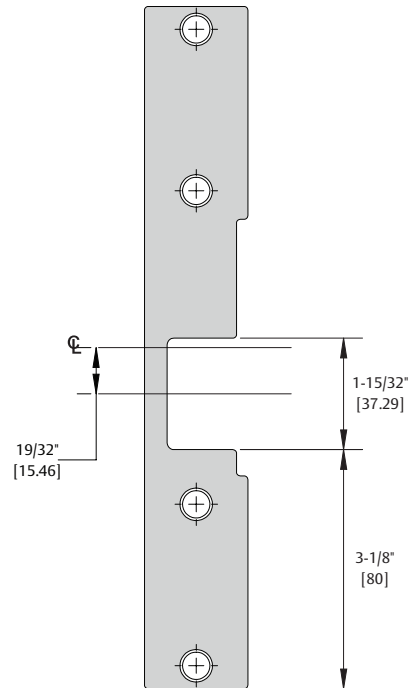

1N-2
Faceplate Option

