

The Falcon 24 and 25 Series

The perfectly simple, tougher than nails, costs less than you think, fits anywhere exit device.

Offices, banks, assisted living facilities, retail stores and other commercial buildings have constant traffic, so door hardware must be able to take continual use and abuse. The Falcon 24 and 25 Series exit devices fill the bill with some of the toughest, most reliable performance in the business. A host of features makes this a smart solution, like a choice of an A or B label fire rating, electrified and panic options, and a full complement of trims. Sleek, streamlined styling and a choice of wide (25 Series) and narrow stile (24 Series) device applications means a smart solution for your building design, as well as its use. And since they're backed by one of the best names in the business, you can be sure you're getting the utmost value, reliability and durability.

Features

Streamlined design includes flush-end cap for clean lines and a more attractive installation.

Clean design with no exposed screws or rivets on the back of the device.

Patent-pending deadlocking technology ensures reliable security.

One trim input design for maximum versatility.

Extruded aluminum construction delivers greater strength and impact resistance.

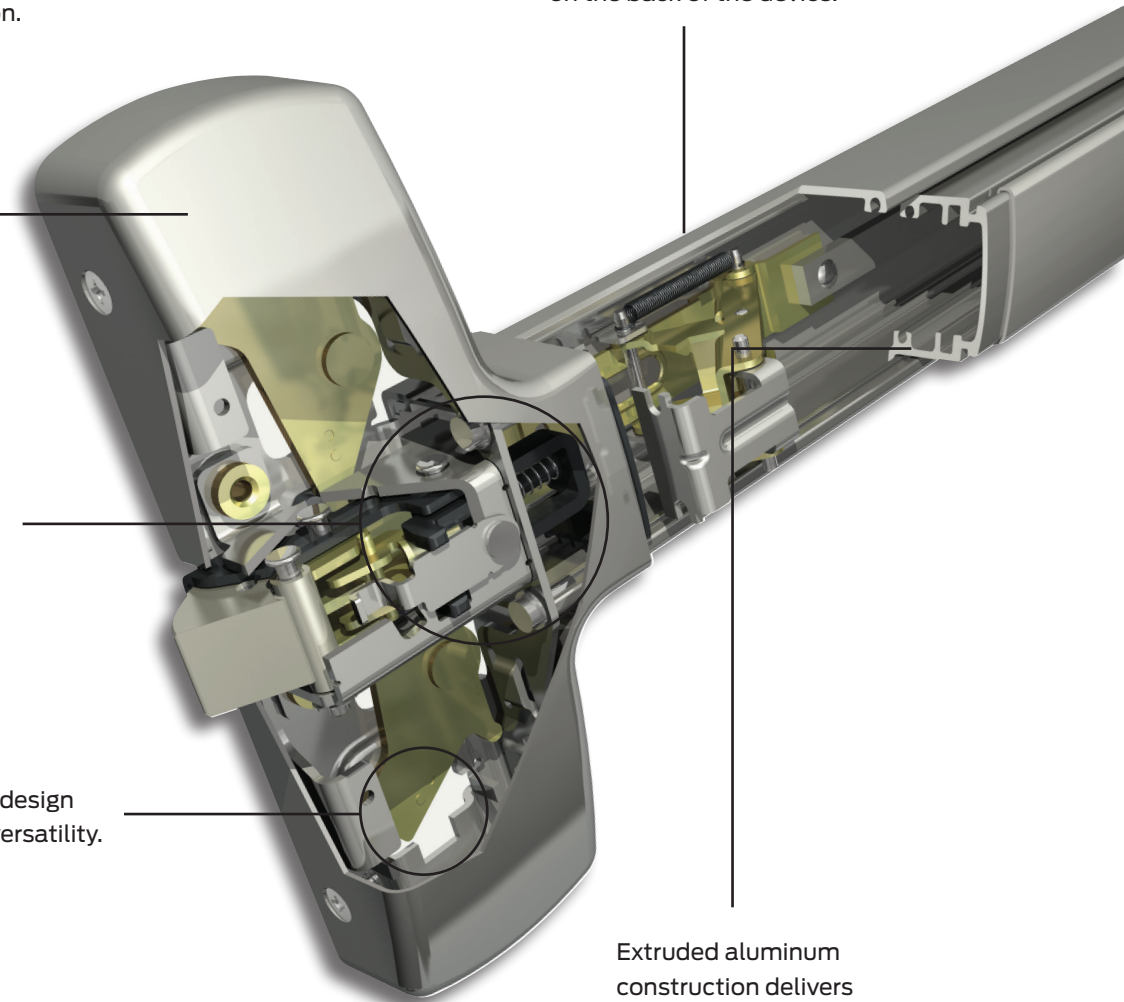

Falcon exit devices

Architectural pushpads

Commercial pushpads



24/25 Series

19 Series

1490/1590

1690/1790

Selling features	<ul style="list-style-type: none"> • Maximum flexibility in a variety of applications • Wide range of features and options • Patent pending deadlocking technology 	<ul style="list-style-type: none"> • Lowest cost most dependable light-duty exit • Large trim selection • Standard deadlocking 	<ul style="list-style-type: none"> • Steel operating mechanisms • Aluminum push bar and end caps • Durable design • Surface vertical and rim options available 	<ul style="list-style-type: none"> • Patented pending latchbolt for hurricane ratings • #1 selling exit device for aluminum doors • Full compliment of electrical options • Durable design 	
	Applications	<ul style="list-style-type: none"> • Frequent traffic • Offices, churches, hospitality, retail, education, healthcare • Interior, exterior, new construction, retro-fit 	<ul style="list-style-type: none"> • Moderate traffic • Commercial, multi-family, office, retail • Interior, exterior, retro-fit 	<ul style="list-style-type: none"> • Moderate traffic • Commercial, multi-family, office, retail • Interior, exterior, retro-fit 	<ul style="list-style-type: none"> • Moderate traffic • Commercial, multi-family, office, retail • Interior, exterior, retro-fit
	Device options	<ul style="list-style-type: none"> • Rim, SV, CV, M • 6 functions /9 finishes • 4 lever designs • 10-year warranty 	<ul style="list-style-type: none"> • Rim, SV • 7 functions /4 lever designs • 3 finishes • 10-year warranty 	<ul style="list-style-type: none"> • CV=1490/Rim=1590 • 4 functions/10 finishes • 3 length options • 10-year warranty 	<ul style="list-style-type: none"> • CV = 1690/Rim = 1790 • 4 functions/7 finishes • 4 length options • 10-year warranty

Crossbars

Recessed/ concealed devices



XX

1990

2090

2390

<ul style="list-style-type: none"> • Classic traditional design • Dependable and attractive • Economic crossbar option • Panic and fire rated options 	<ul style="list-style-type: none"> • Classic industry look • Balanced appearance, dependable performance and economical pricing • Hardened steel latches • Adjustable strike to ensure safety, security and smooth operation 	<ul style="list-style-type: none"> • Classic looks in a rim device • Designed for high use and abuse • 1/2" inch steel latchbolt • Surface mounted strikes for full frame or blade type stops 	<ul style="list-style-type: none"> • Reduced projection recessed device • Tough, reliable performance • Easy rod adjustment simplifies installation • Smooth, reliable operation
<ul style="list-style-type: none"> • Light/moderate traffic • Commercial, multi-family, office, retail • Interior, exterior, retro-fit 	<ul style="list-style-type: none"> • Light traffic • Commercial, multi-family, office, retail • Interior, exterior, retro-fit 	<ul style="list-style-type: none"> • Light traffic • Commercial, multi-family, office, retail • Interior, exterior, retro-fit 	<ul style="list-style-type: none"> • Moderate/ frequent traffic • Healthcare, assisted living, education • Interior, new construction
<ul style="list-style-type: none"> • Rim, SV, CV, M • 13 functions/8 finishes • 5 lever options • 10-year warranty 	<ul style="list-style-type: none"> • CV • 4 functions/10 finishes • 2 length options • 10-year warranty 	<ul style="list-style-type: none"> • Rim • 4 functions/10 finishes • 2 length options • 10-year warranty 	<ul style="list-style-type: none"> • CV • 3 functions/4 finishes • 2 length options • 10-year warranty

F-25-M Series

Mortise device

🔥 Fire exit hardware

The Falcon F-25-M Series delivers the safety of a fire-rated exit device with a choice of ratings. The F-25-M can be paired with a Falcon mortise lock, assuring a tough and secure lock for any opening requiring a high level of safety and security.



Device	Door size	Door strike	Door stile (in)	Min door opening width
F-25-M	3'	All	4 1/2"	2' 7 1/2"
F-25-M	4'	All	4 1/2"	3' 2"

Specifications

Hand:	Handed.
UL:	"A" label (3 hr.); 4'0" x 10'0" single doors; 8'0" x 10'0" pair of doors (F-25-M x F-25-V or F-25-C). "B" label (1-1/2 hr) with F1280 open back strike.
Finishes:	US3 (605); US4 (606); US10 (612); US11 (643e); US15 (619); US19 (622); US26 (625); US26D (626); US32 (629); US32D (630); US28 (628), 313AN (710) (See page 17 for finishes.)
Strikes:	1279 standard. F1280 optional, B label (1 1/2 hr.).
Latchbolt:	Stainless steel, 3/4" throw.
Deadlocking latchbolt:	Standard.
Stock sizes	See chart.
Doors:	1 3/4" thick, wood or metal. Specify thickness if other than 1 3/4".
Projection:	2 3/4" maximum.
Stile:	4 1/2" minimum.
Mounting height	40 1/4" from CL to finished floor. For mortise lock prep per ANSI A115.1-1990.
Electric functions:	Can be interfaced with building security systems. Motorized electric latch retraction (fail secure only, not available with MEL), FSA/FSE trim, security monitoring, delayed egress and exit alarm available.
Fasteners:	All mounting screws are concealed. All machine screws (AMS) standard.
Sex bolts:	Required when used with wood, composite or non-reinforced hollow metal doors. For EO device specify 6 - 425 (#10-24) SNB. For devices with trim, specify 2 - 425 (#10-24) SNB.
ANSI:	Certified ANSI A156.3-2001 grade 1 standards.
Mortise lock:	Heavy wrought lock case with investment cast or sintered steel parts. Lock face is forged brass—fits standard cutout. Locks are designed to fit standard ANSI A115.1 preparation for 1 3/4" doors. Deadlocked when auxiliary bolt is depressed 5/16".
Shim kits:	For glass lite applications; 1/4" thick, specify SK25-RM.

25 Series

Strikes and accessories

Strikes

For rim devices



264
2 7/8" x 1 1/4" x 9/16"
(H x W x D)
Panic device only.



299
7 7/8" x 1 1/4" x 13/16"
(H x W x D)
Panic device only.



299F
2 7/8" x 1 1/4" x 13/16"
(H x W x D)



499F
3 5/8" x 1 1/2" x 16/16"
(H x W x D)



1439 Blade stop
1 3/4" x 1 7/8" x 1/2"
(H x W x D)
Panic device only.



1606
2 7/8" x 1 3/8" x 3/8"
(H x W x D)
Panic device only.



1609
3 1/4" x 1 1/16" x 3/8"
(H x W x D)
Requires coordinator.
Panic device only.

For surface and concealed vertical rod devices



2130
(F)25-V and (F)25-C
standard bottom strike for
grouting into concrete or
masonry floors.



3788
Furnished top
of (F)25-V.



4155
Optional strike.
Panic device only.



4188
Top strike for
(F)25-C.

For mortise lock devices



1279
Closed strike used on
single doors and on fire
exit hardware doors with
coordinator.

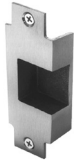

F1280
Open back strike used on pairs of
1 3/4" doors without astragal or
coordinator. Can be used on stock
hollow metal doors. F1280 "B" label
(1 1/2 hr.) stainless steel strike
available.



1281
Open back strike for 1 3/4" doors.
8" x 1 1/4" face allow use in
mortise lock cutout of stock
hollow metal door.

Accessories

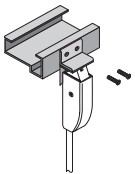

4215
Angle bracket for flush transom applications.
Does not require elimination of latch retention
feature. Accepts 3788 strike for 25-V device.

Surface vertical extension rods

Extension rods are available in 12", 24" and 36" lengths in all finishes. Both ends tapped and all-thread included as connector.



Concealed extension rods

Extension rods are available in 12", 24" and 36". Both ends have pressed-in, threaded inserts.



Filler Plates

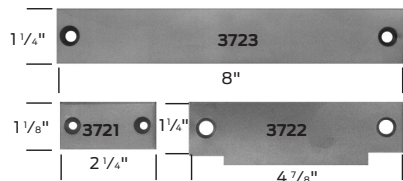

3721/ 3722/ 3723
Steel filler plates

- 3721 Cylindrical lock front filler
- 3722 Strike filler - set no. SC for 161 cutout
- 3723 Mortise lock front filler
- 3722 Strike filler - set no. SM for 86 cutout

25 Series

Trim designs

Functionality built into the trim, facilitating easy door preps, easy field retrofit and easy ordering.

Lever trims (510L)

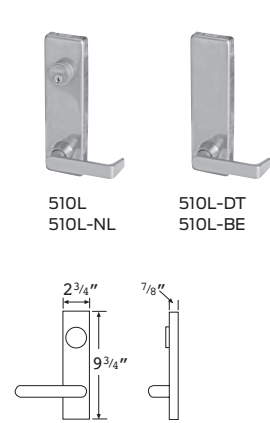

510L
510L-NL

510L-DT
510L-BE

Lever designs



Avalon (AVA)
Projection 3 1/4"



Quantum (QUA)
Projection 3 1/4"



Dane (DAN)
Projection 3"



Broadway (BRW)
Projection 3 1/5"



Boardwalk (BRK)
Projection 3 1/5"



Danish (DSH)
Projection 2 9/16"



Latitude (LAT)
Projection 3 1/16"



Longitude (LON)
Projection 3 1/16"



Sutro (SUT)
Projection 3 1/4"

All levers return to within 1/2" of door.
Escutcheon: 9 3/4" (H) x 2 3/4" (W) (specify handing) brass finish.
Protected by easily replaceable shear pin.
Lever is reversible, supplied RHR if not specified. For keyed functions, see page 14 for cylinder requirements.

Vandal - resistant lever trims (511L)



Provides resistance to rotation, making damage of trim due to attack from the outside less likely. Designed to operate normally after vandalism attempts without the need for maintenance personnel intervention.

- Heavy duty, vandal-resistant, ANSI A156.3 grade 1 security trim
- Lever deflects up to 22 ft-lb for a minimum of 10,000 vandal-resistant cycles
- Vandal resistance is present in both lever rotation directions
- After lever is fully deflected, lever stops rotating and a shear pin breaks at 70 ft-lb to prevent damage to unit
- Available on 25 rim, vertical, mortise, and concealed devices
- Retrofits all existing 25 trim without additional door prep
- Works with all electric lock and unlock functions
- Available in all finishes and lever designs including Avalon, Boardwalk, Broadway, Dane, Danish, Latitude, Longitude, Sutro, and Quantum

Pull trims (512)



512TP

512NL

512DT

512TP-BE

717DT

Escutcheon: 16" x 2 3/4"
Grip: 6 1/4" C-C
Projection: 2 11/16"
Brass
For keyed functions, see page 14 for cylinder requirements.

Delta (717)



Knob trims (513K)



513K-DT
513K-BE

513K
513K-NL

Round ball knob
Escutcheon: 9 3/4" x 2 3/4"
Projection: 4"
Brass
For keyed functions, see page 14 for cylinder requirements.

Cylinder only (NL-OP)

Key retracts latch bolt.
Cylinder sold separately (see page 14).













25 Series

Trim chart & finish chart

Function

	Lock/ unlock	NL	DT	BE	FSA/ FSE
Lever (510)	510L	510L-NL	510-DT	510L-BE	510L-FSA 510L-FSE
Vandal-resistant lever (511)	511L	—	—	—	511L-FSA 511L-FSE
Pull trims (512)	512TP	512-NL	512DT	512TP-BE	512L-FSA 512L-FSE
Knob (513)	513K	513K-NL	513K-DT	513K-BE	513L-FSA 513L-FSE
Delta (717)	—	—	717DT	—	—

25 Series finishes











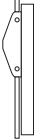

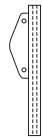







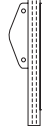

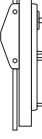
	Color	US number	BHMA number
	Brass, bright	US3	605
	Brass, satin	US4	606
	Bronze, satin	US10	612
	Bronze, aged	US11	643e*
	Nickel, satin	US15	619*
	Black, matte	US19	622*
	Chromium, bright	US26	625
	Chromium, satin	US26D	626
	Anodized aluminum	US28	628
	Stainless Steel, bright	US32	629
	Stainless Steel, satin	US32D	630
	Anodized duranodic	313AN	710

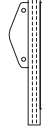
*Available on select devices and trims

25 Series

Types and functions

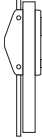
This page shows all 25 Series device and trim functions.

	Rim device ANSI type 1	Vertical rod device ANSI type 2	Mortise lock device ANSI type 3	Concealed vertical rod device ANSI type 8
Functions (ANSI)	(F)-25-R	(F)-25-V	(F)-25-M	(F)-25-C
EO (01) Exit only, no trim.				
	25-R-EO	25-V-EO	25-M-EO	25-C-EO
DT (02) Entrance by trim when actuating bar is locked down.				
	25-R-DT	25-V-DT	25-M-DT	25-C-DT
NL (03) Entrance by trim when latchbolt is retracted by key. Key removable only when locked.				
	25-R-NL	25-V-NL	25-M-NL	25-C-NL
TP (05) Entrance by thumbpiece. Key locks or unlocks thumbpiece.				
	25-R-TP	25-V-TP	25-M-TP	25-C-TP
L or K (08) Entrance by knob or lever. Key locks or unlocks knob.				
	25-R-L/K	25-V-L/K	25-M-L/K	25-C-L/K
L(NL) or K(NL) (03) Entrance by knob or lever when latchbolt is retracted by key. Lever/knob is rigid. Key removable only when locked.				
	25-R-L/K(NL)	25-V-L/K(NL)	25-M-L/K(NL)	25-C-L/K(NL)

25 Series

Door application

Label doors

Models F-25-R, F-25-M, F-25-C and F-25-V are labeled for use as  Fire exit hardware.

Door thickness

All devices and components supplied for 1 3/4" doors standard. Specify door thickness if other than 1 3/4".

Door application chart

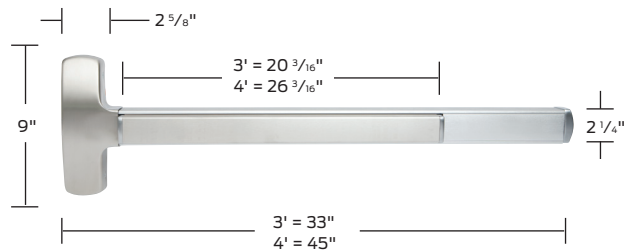
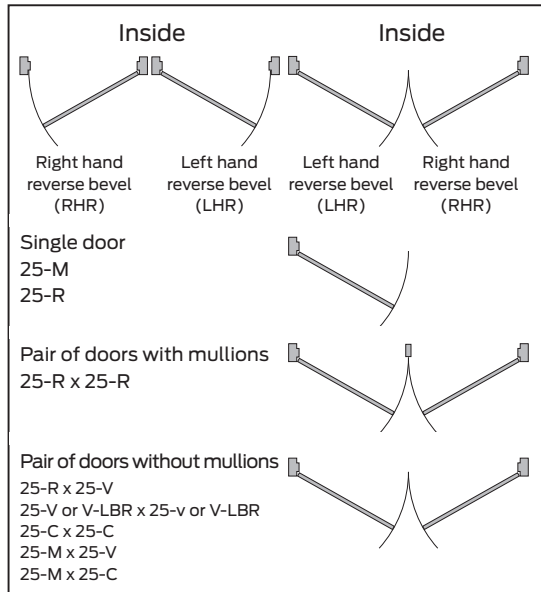

Product information and specifications contained in this catalog are subject to change without notice. Please consult the factory.

Delayed egress system components

For all 24 and 25 Series

The delayed egress system provides control for limited egress and high security areas which require accident hazard or fire exit hardware.

Delayed egress function

When the delayed egress system is armed, the mag lock(s) will remain secure against attempted override pressure and severe impacts. Ingress requires an operational trim, along with access control input (i.e. card reader, key switch, keypad). The system is required to be tied into local fire alarm system.

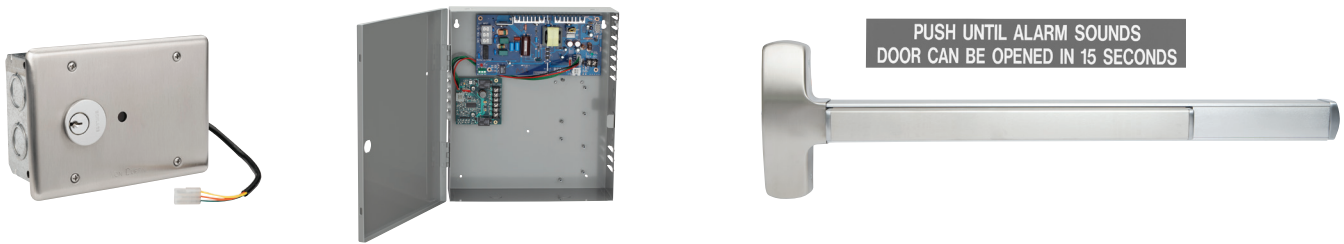

A complete delayed egress system requires the following components:

- DE5300 is used in delayed exit application and is ideal for controlled areas.
- Key switch operator
- Arm, disarm, reset and bypass the delayed egress system by the mortise cylinder on the dialogue box. (1-1/4" mortise cylinder sold separately.)
- LED status indicator
- Red LED indicates arm. Disarm and alarm status.
- Alarm horn
- Depression of the Falcon 24 or 25 RX device touchpad initiates a local alarm of 100 dB when armed.

Falcon 25 Series device with RX switch

PS902 Power supply

- PS902 - The series PS902 power supply is the recommended power supply for use with the delayed egress system. The series PS902 power supply is designed for electric locking or monitoring on single or double door applications. The output power is field selectable for either 24 VDC@1 ampere or 12 VDC@2 ampere. Standard input 120 VAC@0.6 ampere and 240 VAC@3.0 ampere available. The terminal block will accept up to 14 gauge stranded wire.

Power supply

- **PS900 Series** - A PS900 Series power supply can be safely used with the delayed egress system (see page 39 for more information).

Magnetic locks - Schlage electronics M420, M450 or M490 maintains UL listing.

How to order:

All components above are sold separately. To order, specify each component to complete a delayed egress system for your application.

Application and wiring

Popular delayed egress diagram

Minimum door opening sizes

(Jamb to jamb, or for double door- jamb to center of opening)

Device	Door size	Door strike	DE5300 for standard devices
24-R	3'	299	2' 7 1/2"
		264	2' 7 3/8"
		1439	2' 6 3/4"
		1606	2' 7 1/8"
24-R	4'	299	3' 1 1/2"
		264	3' 1 3/8"
		1439	3' 1 1/8"
		1606	3' 1 1/8"
24-C	3'	All	2' 7 1/8"
24-C	4'	All	3' 1 1/8"
25-R	3'	299	2' 7 3/4"
		264	2' 7 3/8"
		1439	2' 6 3/4"
		1606	2' 7 1/8"
25-R	4'	299	3' 1 1/2"
		264	3' 1 3/8"
		1439	3' 1 1/8"
		1606	3' 1 1/8"
25-C	3'	All	2' 7 3/8"
25-C	4'	All	3' 1 3/8"
25-M	3'	All	2' 7 1/2"
25-M	4'	All	3' 2"

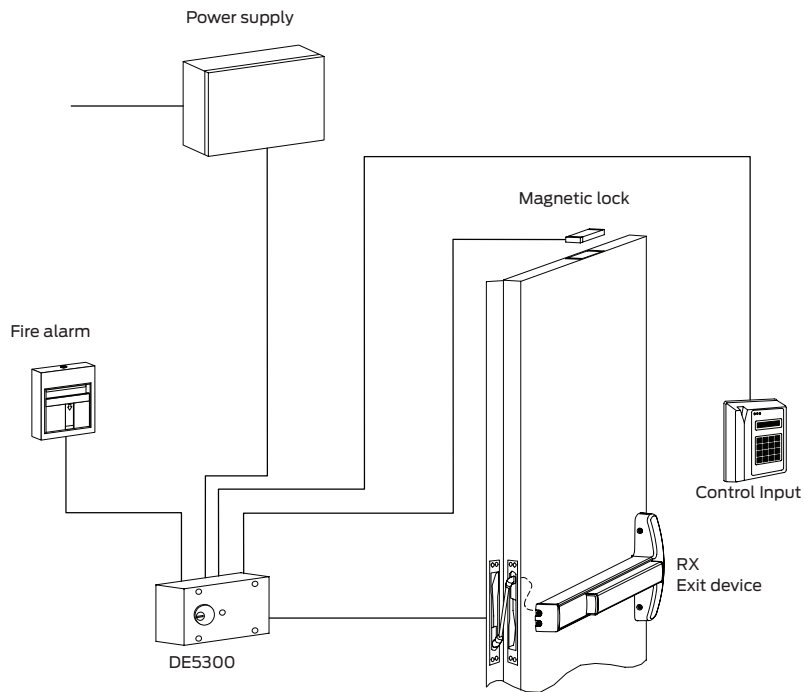

Electric lock or unlock trim

Electric lock or unlock trim (FSA/FSE) for 25 Series

The electric lock or unlock (FSA/FSE) feature allows the controlling of trim while still maintaining free egress at all times. The lock or unlock command can be controlled by a security system, fire alarm system, key switch, card reader, push button or touchpad.

FSA (Fail safe—unlocks when power is interrupted) can be used in areas requiring doors to be unlocked due to fire, power failure or emergency situations. (Examples: stairwells, hospitals, fire exits, etc.)

FSE (Fail secure—locks when power is interrupted) can be used in areas requiring doors to be locked for security reasons and only unlocked when energized by authorized personnel. (examples: banks, inner-office, etc.) With either feature, authorized personnel can gain access utilizing key by overriding or bypassing electric locking function.



Specifications

- Solenoid rated for continuous duty at 24V DC 0.4 amps.
- UL listed devices.
- Device channel is used as conduit on 25 Series devices.
- Power transfer (EPT-2) hinge 2-wire minimum rated 1/2 Amp.
- See page 35 for more information

How to order

To order FSA/FSE feature, add FSA or FSE prefix to device designation. (Example: FSA 25-R-L)

Note:

1. FSA/FSE can be used on all devices.
2. The FSA/FSE feature can be used in conjunction with MEL (Motorized electric latch retraction), EA (exit alarm) and security monitoring (DM, LM, RX).

Minimum power supply- PS902

- The series 902 power supply is the recommended power supply for use with an FSA or FSE trim. The series 902 power supply is also designed for electric locking or monitoring of single or double door applications.
- See page 32 for more information

Wire chart

Length of wire run (ft.)	24VDC 0.4 AMPS
0-500	18AWG
501-700	16AWG

Exit alarm

Exit alarm (EA) - for all 24 and 25 Series devices

The Exit alarm (EA) feature provides a battery powered exit alarm to allow for a simple and effective means of monitoring the use of exits while still maintaining means of egress (for code requirements). When the touchbar is depressed the alarm will sound continuously, indicating that the exit has been engaged. The exit alarm can only be reset by way of a standard 1 1/4" mortise cylinder with standard "A" cam (5/16" wide x 3/4" long). The design of the unit will allow the single 9V battery to last for at least six months (on standby mode).



Minimum door width required for standard devices

Device	Door size	Door strike	Min door opening width
EA-24-R	3'	299	2' 9 1/4"
		264	2' 9 1/8"
		1439	2' 8 3/8"
		1606	2' 8 7/8"
EA-24-R	4'	299	3' 3 1/4"
		264	3' 3 1/8"
		1439	3' 3 7/8"
		1606	3' 3 7/8"
EA-24-C	3'	All	2' 9 1/8"
EA-24-C	4'	All	3' 3 1/8"
EA-24-V	3'	All	2' 8 7/8"
EA-24-V	4'	All	3' 2 7/8"
EA-25-R	3'	299	2' 9 1/4"
		264	2' 9 1/8"
		1439	2' 8 3/8"
		1606	2' 8 7/8"
EA-25-R	4'	299	3' 3 1/4"
		264	3' 3 1/8"
		1439	3' 3 7/8"
		1606	3' 3 7/8"
EA-25-C	3'	All	2' 8 7/8"
EA-25-C	4'	All	3' 2 7/8"
EA-25-M	3'	All	2' 9 1/4"
EA-25-M	4'	All	3' 3 1/4"
EA-25-V	3'	All	2' 8 7/8"
EA-25-V	4'	All	3' 2 7/8"

Specifications

- Works with rim, mortise, concealed, surface vertical rod
- UL listed
- The EA feature can be used in conjunction with FSA/FSE (Fail safe/Fail secure trim) and security monitoring (DM, LM, RX) features.

Features and benefits

- 110 dB alarm
- 24 Volt hardwire option
- 9V Battery input
- External inhibit for card reader
- LED indication
 - Armed
 - Disarmed
 - Low battery
 - EAK retrofit kit available for your existing devices

How to order

To order EA feature add "EA" prefix to device designation. (example: EA-25-R-EO)

To order EAK (exit alarm kit) feature order "EAK" plus device length (3' or 4'), type of device (24 or 25 Series) and the finish of your existing device. (example: EAK-4', 24 Series, US10) (For retrofit application)

Minimum power supply - PS902

The series PS902 power supply is the recommended power supply for use with the exit alarm (EA) option. The series PS902 power supply is designed for electric locking or monitoring on single or double door applications (see page 32 for more information).

Device monitoring

Device monitoring for most 24 and all 25 Series devices*

All of the monitoring features available from Falcon provide total flexibility and will interface with any security system. All monitoring switches are dry contact type and are contained within the device, allowing for tamper-resistant operation. Security monitoring features allow monitoring of devices, latches, authorized egress and locking levers. A key override option is available. All of the security monitoring features can be used in any combination with any other Falcon feature. Consult factory for special applications.

***DM, *LM, RX Monitoring**

- The DM (device monitor) feature monitors full latch projection. If the latchbolt is retracted by use of device, or someone tampers with the latchbolt, the switch is activated sending a signal to controlling areas. In devices with the deadlock feature, the deadlatch status is monitored.
- The LM (Latch monitor) feature monitors full latchbolt retraction. When the latchbolt is fully retracted a signal is sent indicating door (or device) opened status.
- The RX feature monitors the depression of the touch bar or crossbar. Activation of the switch indicates use of a door or that the door is in the dogged condition. This feature is especially useful when used to activate or shunt magnetic locking systems.
- *LM/DM not available on F-24-R.

How to order

To order any individual or combination of monitor feature(s) add the respective prefix(s) to device designation. (example: EL-RX-DM-25-V-L-DANE)

Key override option (KOR)

The KOR feature allows authorized personnel to override monitoring features on a door by use of a keyed 1 1/8" mortise cylinder with 5/16" wide x 3/4" long standard cam (mortise cylinder not supplied).

Activating KOR feature allows any feature to be disabled for daytime use or when desired by key holder. This is a maintained contact switch. KOR is especially useful for turning on or off magnetic locking systems and electric dogging control (at the door).

This feature is not available with EA feature, cylinder/standard dogging.

To order KOR feature add KOR prefix to device designation. (example: KOR-DM-24-R-TP)

Note: Use of these features may require a power transfer hinge (supplied by others) or additional wires in the power transfer hinge needed for application when combined with other electrified features.

Power supply



The PS900 Series is a consolidated line of power supplies and accessories that offer enhanced flexibility and functionality specific to the changing needs of the access control market. The PS900 Series can be used in a variety of applications to convert high voltage AC power into the low voltage DC outputs required by most access control devices. The PS900 Series protects devices downstream by providing Class 2*, filtered and regulated power. The full line is UL294 certified.

Note: PS906 can provide Class 2 rated outputs when used with 900-8P distribution board.

Features:

- Constant output rating at both 12 VDC and 24 VDC provides superior performance; includes field selectable jumper
- Polarized connectors for option boards eliminate need for racks and side connectors
- Flat mounting of option boards provides easier access to terminal blocks for connection of electrified devices
- High voltage protective cover
- Battery back-up board auto-selects voltage
- Fire alarm relay can be configured to provide either switched or un-switched outputs from a power supply
- PS914 designed with high in rush current for powering solenoid-driven electrified panic devices
- Universal 120-240 VAC input
- Low voltage DC, regulated and filtered
- Electronic power limiting foldback circuit for AC current overload protection
- Fused primary input
- AC status monitor- isolated SPDT contacts
- AC input and DC output LED status indicators
- Cover mounted AC input indication
- Hinged cover with lock down screws

Certifications:

- UL 294 certified—the standard for access control
- Class 2 rated*
* Except PS906, output rating exceeds Class 2 power limits

Once power is converted to low voltage DC, the PS900

Series offers a variety of distribution options, including basic fuse protection, simple relay, and advanced logic providing complex sequencing and timing functions.

* PS906 can provide Class 2 rated outputs when used with 900-8P distribution board.

	PS902	PS904	PS906	PS914
Number of connectors on power supply for the following:	2 amps	4 amps	6 amps	4 amps
Distribution boards	1	2	3	2
Battery back-up board	1	1	1	1

Note: One fire alarm board can be connected directly to the PS902. If a fire alarm board is desired for the PS904, PS906 or PS914 it can be connected to a distribution board.

Applications:

The PS900 Series of power supplies works with many electrified devices including Falcon exit devices, electromagnetic locks, hardwired locks, electrified mechanical locks, electrified strikes and many other products.

Accessories:

The PS900 Series features seven option boards for use in a variety of applications. All PS900 Series power supplies option boards are UL 294 certified.

Option boards:

900-4R: 4 relay controlled output board to power multiple devices.

900-4RL: 4 relay distribution board with logic is field configurable for time delay function, auto operator, security interlock.

900-8F: Provides 8 individually fuse-protected outputs, giving the flexibility to power multiple devices and provide another layer of protection.

900-FA: Emergency interface relay integrates with fire alarm and is used to cut power in case of emergency.

900-BB: Battery backup.

900-2RS: 2 relay MEL or EL panic device control board.

900-BBK: Battery backup kit includes two 7A/hr batteries and provides up to four hours of backup power when cycled every 5 minutes at full load.

Wire selection size/type

Run length (one way)	MEL device w/EPT, electric hinge, door loop
200'	18 AWG
320'	16 AWG
500'	14 AWG
800'	12 AWG

Electrical options summary

Electrical options matrix - 25 Series

Option	Electric dogging	Motorized electric latch retraction (MEL)	Delayed egress	Electric lock /unlock trim (FSA/FSE)	Device monitor (DM)	Latch monitor (LM)	Authorized egress (RX)	Key override (KOR)	Exit alarm (EA)
Motorized electric latch retraction (MEL)	X	—	V	V	V	V	V	X	X
Delayed egress	V	V	—	V	V	V	V	V	V
Electric lock/unlock trim (FSA/FSE)	V	V	V	—	V	V	V	V	V
Device monitor (DM)	V	V	V	V	—	V	V	V	V
Latch monitor (LM)	V	V	V	V	V	—	V	V	V
Request to exit (RX)	V	V	V	V	V	V	—	V	V
Key override (KOR)	X	X	V	V	V	V	V	—	X
Exit alarm (EA)	X	X	V	V	V	V	V	X	—

Electrical options matrix - 24 Series

Option	Electric dogging	Motorized electric latch retraction (MEL)	Delayed egress	Device monitor (DM)	Latch monitor (LM)	Authorized egress (RX)	Key override (KOR)	Exit alarm (EA)
Motorized electric latch retraction (MEL)	X	—	V	V	V	V	X	X
Delayed egress	V	V	—	V	V	V	V	V
Device monitor (DM)*	V	V	V	—	V	V	V	V
Latch monitor (LM)*	V	V	V	V	—	V	V	V
Request to exit (RX)	V	V	V	V	V	—	V	V
Key override (KOR)	X	X	V	V	V	V	—	X
Exit alarm (EA)	X	X	V	V	V	V	X	—

*Not available on 24-R/F-24-R.

V = works with

X = doesn't work

How to order

25 Series

	MEL	F	25	V	L-DANE	US3	3'	LHR	LBR	SNB	WD
Prefixes											
CD	Cylinder dogging										
RX	Touchbar request to exit										
DM	Latchbolt and device monitor switch										
EA	Exit alarm										
KOR	Key bypass switch										
LD	Less dogging										
LM	Latchbolt status switch										
MEL	Motorized electric latch retraction										
FSA	Electric lock or unlock trim-fail safe										
FSE	Electric lock or unlock trim-fail secure										
Rating											
F	Fire exit hardware										
Blank	Panic exit hardware										
Device series											
25	Touch bar device, wide stile										
Device type											
R	Rim			C-WDC		Concealed vertical rod wood door (20 or 90 min)					
V	Surface vertical rod										
C	Concealed vertical rod			M		Mortise					
Trim function (see trim pages for all functions)											
EO	Exit only			K		Knob					
DT	Dummy trim			L		Lever (Dane standard)					
NL	Night latch			C		Cylinder prim plate					
NL-OP	Night latch optional pull			511-L		VR trim					
TP	Thumbpiece										
Finish											
US3	US10	US11	US15	US19	US26						
US32	US28	US4	US26D	US32D	313AN						
Door width											
3'	Standard default			Door thickness							
4'				1 3/4" Standard							
				2 1/4" Optional							
Handing											
RHR	Right hand reverse										
LHR	Left hand reverse										
Less bottom rod											
LBR	Less bottom rod										
Accessories											
CYL	Cylinder			SNB		Sex bolts					
SK	Shim kit			AMS		All machine screws (for vertical and concealed only)					
Other miscellaneous door information											
HMD	Hollow metal door			—		Door thickness					
HMF	Hollow metal frame			—		Door undercut					
WD	Wood door			—		Door label					
WDF	Wood frame			—		Stile width					
ALD	Aluminum door			—		Frame stop height					
ALF	Aluminum frame			SGL		Single door					
SCDC	Steel channel door construction			PR		Pair of doors swinging same direction					
—	Specify other door or frame										
—	Material information										
—	Door height										

How to order

Trim

		510	L	R	US26D	LHR	SUTRO	FSE	CYL
24 Series	25 Series								
711	510								
712	511								
715	512								
717	513								
718	717								
	718								
Trim function (see trim pages for all functions)									
EO	Exit only	K	Knob						
DT	Dummy trim	L	Lever (Dane standard)						
NL	Night latch	KIL	Key in lever						
C	Cylinder trim less pull	TL	Thumb lever						
TP	Thumbpiece								
Device type									
R	Rim								
V	Surface vertical rod								
C	Concealed vertical rod (includes WDC)								
M	Mortise								
Finish									
US3	US4	US10	US10B	US11	US15	US19			
US26	US26D	US32	US32D	SP28	SP313				
Handing									
RHR	Right hand reverse								
LHR	Left hand reverse								
Lever style									
	Dane (DAN)								
	Sutro (SUT)								
	Quantum (QUA)								
	Avalon (AVA)								
	Boardwalk (BRK)								
	Broadway (BRW)								
	Danish (DSH)								
	Latitude (LAT)								
	Longitude (LON)								
Other miscellaneous door information									
FSA	Electric Lock or Unlock-Fail Safe (FSA device required)								
FSE	Electric Lock or Unlock-Fail Secure (FSE device required)								
CON	Allegion Connect								
Accessories									
CYL	Cylinder								
KD	Cylinder keyed different								
Door thickness									
Specify door thickness other than 1 3/4"									

FALCON®

Motorized Electric Latch Retraction-MEL

Featuring 24 and 25 Series
exit devices



Overview

Motorized electric latch retraction (MEL) provides energy efficient electronic control of an exit device for an affordable around the door solution. The MEL option is Falcon's® solution of choice for multifamily and commercial real estate facilities where cost competitive electromechanical latch retraction is desired. It is available on Falcon 24 and 25 Series exit devices, except 25-M (mortise).

These devices always provide mechanical egress. Motorized electric latch retraction can be used with credential readers to unlatch doors momentarily for authorized users, or it can be incorporated with systems to retract latches for extended periods of time to allow free entry. This is a convenient alternative to mechanical dogging. Doors with automatic operators also often incorporate exit devices with electric latch retraction.

The MEL option is available on panic and fire rated devices. Because fire exit hardware must be self latching, an automatic fire alarm system must be incorporated to drop power to fire rated MEL devices in case of fire.

Features and benefits

- MEL option available on 24 and 25 Series exit devices, except 25-M (mortise)
- Energy efficient motorized latch retraction enables longer wire runs and the use of a standard Schlage® power supply with option board
- Modular design allows for a simplified installation of the available MEL Conversion kit to existing mechanical Falcon 24 or 25 exit devices
- On-board installation and troubleshooting diagnostics built into the motor assembly
- Self-calibrating motor assembly
- Pushbar is pulled in electronically when dogged
- Vandal resistant – detects and responds to events of attack and tampering
- Available with Allegion Connect (-CON) on full device and kits

Specifications compliance

- MEL is designed for use on exit devices that are BHMA Certified to ANSI/BHMA A156.3
- Exit devices with MEL are UL and cUL Listed as "Panic Hardware" (UL 305) and as "Fire Exit Hardware" (UL 10C)
- The MEL Conversion Kit is UL Classified under "Accessories for Single-Point Locks and Latches and Fire Exit Hardware" (UL 10C)

Electronic specifications

MEL electrical load		MEL wire run lengths	
Voltage	24 VDC	Distance (one way)	Wire gauge
Current	1.0 A Inrush (0.5 sec) 0.14 A Holding	200'	18 AWG
		320'	16 AWG
		500'	14 AWG
		800'	12 AWG

Accessories

The MEL has a low inrush current = 1.0 amps, so it can be used with standard Schlage power supplies. When powering multiple components, verify that the amperage requirement of all components combined does not exceed the power supply output rating. See table below for output ratings.

Schlage PS902	Schlage PS904	Schlage PS906
up to 2 amps	up to 4 amps	up to 6 amps

The MEL device is compatible with the following equipment: PS900 Series power supplies - PS902, 904, 906, 914; 900 Series Option Boards - 900-2RS, 900-4R and 900-4RL. The power transfer (EPT, electrified hinge, or door loop) is also sold separately. Please refer to Falcon catalog for more information on EPT-2/EPT-10 power transfers, electrified hinges, and PS900 series power supplies.

How to order

- To order the MEL feature add "MEL" prefix to device designation (example: MEL-25-R-EO). NOTE: Mechanical dogging is not an option with MEL.
- To order the MEL conversion kit, please specify finish with part number (US3, US4, US10, US26, US26D, US32D, SP28, SP313). MEL conversion kits are only compatible with mechanical Falcon 24 and 25 series exit devices. MEL kits may not be used to convert an EL device.

Model No.	Description	Part number	Part number with Allegion Connect (-CON)
25-MELK-3	25 Motorized Electric Latch Retraction Kit 3'	47266630	47270546
25-MELK-4	25 Motorized Electric Latch Retraction Kit 4'	47266631	47270547
24-MELK-3	24 Motorized Electric Latch Retraction Kit 3'	47266632	47270548
24-MELK-4	24 Motorized Electric Latch Retraction Kit 4'	47266633	47270549

Popular application

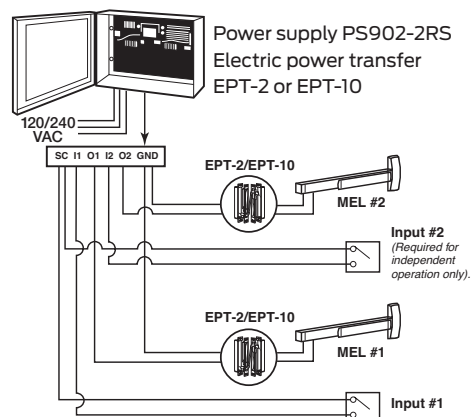

About Allegion

Allegion (NYSE: ALLE) is a global pioneer in safety and security, with leading brands like CISA®, Interflex®, LCN®, Schlage®, SimonsVoss® and Von Duprin®. Focusing on security around the door and adjacent areas, Allegion produces a range of solutions for homes, businesses, schools and other institutions. Allegion is a \$2 billion company, with products sold in almost 130 countries. For more, visit www.allegion.com.

KRYPTONITE ■ LCN ■ **SCHLAGE** ■ STEELCRAFT ■ VON DUPRIN



© 2019 Allegion
012500, Rev. 03/19
www.allegion.com/us