

F-19-V Series non-handed vertical rod device

🔥 Fire exit hardware

Manufactured to the same standards as the F-19 Rim, the F-19-V 🔥 Fire exit device complies with most exit door requirements, and is fully reversible and surface applied. This device is regularly furnished with deadlocking top latch retention and square bolt at bottom. (This device is listed by UL for “B” label fire door installations.) The “EO” (exit only) device is ready to accept any trim function shown on page 17.

 3788
Strike

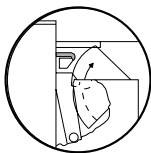
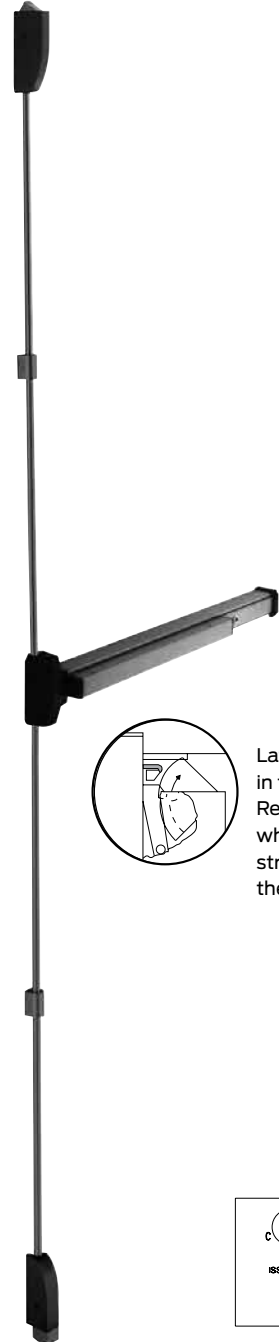

Latch retention hold is in the top latch. Retainer is released when it engages the strike. The door is in the closed position.



 2130
Strike

Device & trim	ANSI type	ANSI function
F-19-V-EO	2 or 5	01
F-19-V-DT	2 or 5	02
F-19-V-NL	2 or 5	03
F-19-V-K (or L or KIL)	2 or 5	08
F-19-V-K-NL (or L-NL or KIL-NL)	2 or 5	09

Note: For blank escutcheon specify BE.

Specifications

Hand:	Field reversible.
Functions:	All functions built into “EO” device. All 19 Series trim works with rim or vertical devices. See Trim Selection Chart on pages 15 and 16.
Finishes:	Powder-coated aluminum—SP28; powder-coated duranodic—SP313; stainless steel US-32D.
Strikes:	3788 strike is surface applied. 2130 strike is mortised into floor.
Latchbolt:	Top stainless steel 3/4" throw. Bottom square bolt 1/2" throw.
Deadlocking latchbolt:	Standard.
Stock sizes:	3' for doors from 2'5" up to 3'. 4' for doors from 3' up to 4'.
Doors:	1 3/4" thick, wood or metal. Specify if other than 1 3/4" thick.
Projection:	2 1/2" maximum.
Fasteners:	All mounting screws are concealed. All machine screws standard.
Sex bolts:	3— #4122 (1/4"-20) SNB standard. Composite or non-reinforced wood, hollow metal require additional sex bolts. F-19-V: 6— #2729 #10-24 SNB; F-19-V-LBR: 3— #2729 #10-24 SNB.
ANSI:	Certified ANSI A156.3-2001 grade 1 standards.
F-19-V:	Latch retention and 3788 strike top deadbolt and 2130 flush strike bottom.
F-19-V-LBR:	Latch retention and 3788 strike top.
Vertical rods:	Furnished to length based on a 40 3/16" horizontal CL from finished floor and a 7'0" door standard. Variations from these standards must be specified when ordering.
Shim kit:	For glass lites applications; 1/4" thick specify SK-19-V-1/4".
161 cutout:	Device covers 161 cutout with KIK/KIL and Centron trims. Other trim requires cover plate.

Trim designs

Control trim

SP28, SP313 and US-32D.

K-control L-control



911K
BE
NL



**L-Control-Avalon
912L**
BE
L-DT
NL



**L-Control-Dane
912L**
BE
L-DT
NL



**L-Control-Sutro
912L**
BE
L-DT
NL



**L-Control-Quantum
912L**
BE
L-DT
NL

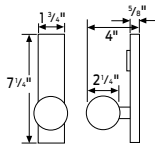

Key locks or unlocks trim. Knob retracts latchbolt when trim is unlocked.

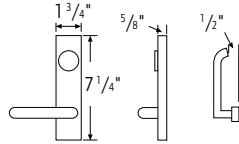

Lever Projection: Quantum = 3"
Sutro = 2 7/8"
Dane = 2 7/8"
Avalon = 3"

Key locks or unlocks trim. Lever retracts latchbolt when trim is unlocked. Dane, Quantum and Sutro levers return to within 1/2" of door.

DT-control



918 DT
Pull when dogged.

NL-control



918NL
Key retracts latchbolt.

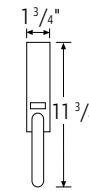

Pull



9970
Can be used with all devices.

9 1/4" center to center
2 7/8" projection
1 3/4" clearance

Cover plates



4167
3 1/4" x 15" x .050
Used with TP control & DT control
Covers 161 & 86 cutouts



4168
3 1/4" x 7 1/2" x .050
Used with EO device to cover No. 86 cutout for mortise lock



4170
3 1/4" x 7 1/2" x .050
Used with K control, DT/K control, L control, or DT/L control
Covers 161 & 86 cutouts

Key-in-lever



914KIL



914-KIL-IC

Centron trim

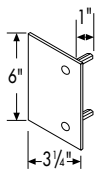

930 EO

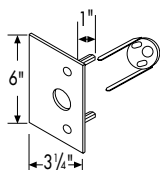

930 C

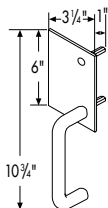

930 DT

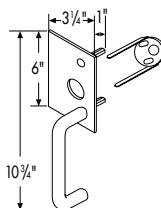

930 NL



Pull only 917 DT
CTC - 5 1/2" round - 3/4" dia.
Pull when dogged.

Trident trim

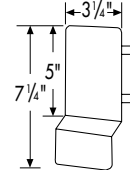

920 DT

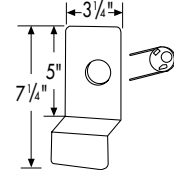

920 NL

Trim chart

Control

Device	DT	NL	T-BE	K	K-BE	K-DT
19-R/19-V	918	918	910	911	911	911
Cylinder type	—	rim	—	1 1/8" Mortise	—	—

Device	Avalon*			Dane*			Sutro*			Quantum*		
	L	L-BE	L-DT	L	L-BE	L-DT	L	L-BE	L-DT	L	L-BE	L-DT
19-R/19-V	912	912	912	912	912	912	912	912	912	912	912	912
Cylinder type	1 1/8" Mortise	—	—	1 1/8" Mortise	—	—	1 1/8" Mortise	—	—	1 1/8" Mortise	—	—

KIL

Device	KIL*	KIL-LS/LK'	KIL-NL*	KIL-IC*
19-R/19-V	914	914	914	914
	Falcon "C" keyway A23160	—	Falcon "C" keyway A23160	Small format

Trident trim

Device	Trident trim		Centron		
	NL	DT	C	DT	NL
19-R/19-V	920	920	930	930	930
Cylinder type	Rim	—	Rim	—	Rim

* Specify hand.

Note: For "NL" night latch function on K and L add "NL" after trim number.
All locking trim except KIL furnished less cylinder.

Type and functions

These pages list all functions available for the 19 Series devices.

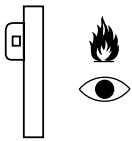
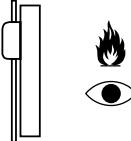
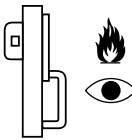
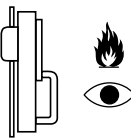
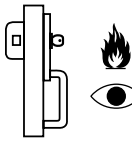
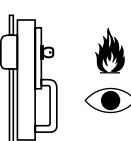
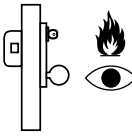
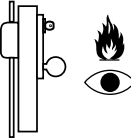
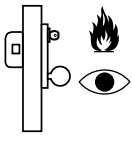
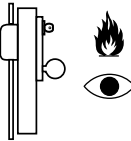
Functions (ANSI)	Rim devices ANSI type 1 and 4. (F)-19-R	Vertical rod devices ANSI type 2 and 5. (F)-19-V
EO or N (01) Exit only, no trim.	 19-R-EO	 19-V-EO
DT (02) Entrance by trim when actuating bar is dogged down.*	 19-R-DT	 19-V-DT
NL (03) Entrance by trim when latchbolt is retracted by key. Key removable only when locked.	 19-R-NL	 19-V-NL
K or L or KIL(08) Entrance by knob or lever. Key locks or unlocks knob.	 19-R-K or L or KIK or KIL	 19-V-K or L or KIK or KIL
K(NL) or L(NL) (09) or KIL (NL) Entrance by knob or lever only when released by key. Key removable only when locked.	 19-R-K (NL) or L(NL) or KIK(NL) or KIL(NL)	 19-V-K (NL) or L(NL) or KIK(NL) or KIL(NL)



Fire exit hardware

Use "F" prefix for fire exit hardware.



Security monitor



Electric function

*Latch, device, and authorize degress monitors. (See electrified hardware catalog.)

*Fire exit devices cannot be dogged down. Some codes permit electric dogging with fail secure circuitry.

Type and functions

Double doors

Device & trim	Length	Top strike	Bottom strike	Min. stile	Door opening width
(F) 19-V	3'0"	3788	2130	3 1/2"	2' 5 1/4" to 3'0"
(F) 19-V	4'0"	3788	2130	3 1/2"	3'0" to 4'0"

Note: For (F-) 19-V-LBR use "V" information less bottom strike. F-19-V-LBR requires use of auxiliary fire latch.

Single doors with 5/8" stop

Device & trim	Length	Strike	Min. stile	Door opening width
19-R	3'0"	F570 565	3 1/2" 1 3/4"*	2'5 1/4" to 3'0" 2' 4 3/4" to 2' 9 1/4"
F-19-R	3'0"	F570	3 1/2"	2'5 1/4" to 3'0"
19-R	4'0"	F570 565	3 1/4" 1 3/4"*	3'0" to 4'0" 3'0" to 3'9 3/4"
F-19-R	4'0"	F570	3 1/4"	3'0" to 4'0"

*For EO, O with pull and NL functions only. 2- 1/4" minimum stile required for control trim.

Dimensions:

- Recommended height from finished floor - 40 5/16" at CL.
- Touchbar projections: neutral - 2 1/2" depressed - 1 7/8"
- Extension rods or longer top rods available upon request.
- Specify door height.
- Dummy touchbar available. Specify 190 DT 3' or 4'.
- Overall length: 3' 30 1/2"- 4' 42 5/8"
- Changes for minimum door size for charts on left:
- For cylinder dogging, add 2 1/4" to minimum door size.
- For exit alarm, add 4 1/2" to minimum door size.
- To fit on smaller door consult factory

Double doors with Mullion

Device & trim	Length	Strike	Min. stile	Door opening width	Fire	Panic
19-R	3'0"	F570	3 1/2" 3 3/4"	2'5 1/4" to 3'0"	-	29231 4023/ KR4-23
		565	3 1/8" 3 3/8"	2'4 3/4" to 2'9 1/4"	-	29231 4023/KR4023
F-19-R	3'0"	F-570	3 3/4"	2'5 1/4" to 3'0"	(F)4023 KR(F)4023	-
19-R	4'0"	F570	3 1/2" 3 3/4"	3'0" to 4'0"	-	29231 4023/ KR4-23
		565	3 1/8" 3 3/8"	3'0" to 3'9 3/4"	-	29231 4023/KR4023
F-19-R	4'0"	F-570	3 3/4"	3'0" to 4'0"	(F)4023 KR(F)4023	-

¹ To cover 161 cutout on double door installation, specify 2923 mullion with 565 strike.

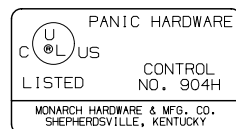

Door applications

Door thickness

All devices and components supplied for 1 3/4" doors standard. Specify door thickness if other than 1 3/4".

Number	BHMA/ANSI function
01	Exit only, no trim.
02	Entrance by trim when actuating bar is locked down.
03	Entrance by trim when latchbolt is retracted by key; key removable only when locked.
04	Entrance by trim when latchbolt is retracted by key or set in a retracted position by key.
08	Entrance by knob or lever; key locks or unlocks knob or lever.
09	Entrance by knob or lever only when released by keys; key removable only when locked.

U.S. standard	BHMA	Description
US28	628	Anodized aluminum – clear
DC13	710	Anodized aluminium – dark bronze
DC35	711	Anodized aluminum – black
P28	689	Painted aluminum – silver
P13	695	Painted aluminum – dark bronze
P35	622	Painted aluminum – black
US3	666	Bright brass
US4	667	Satin brass
US9	705	Bright bronze
US10	668	Satin bronze
US10B	703	Oxidized satin bronze
US14	669	Bright nickel
US15	670	Satin nickel
US26	672	Bright chrome
US26D	702	Satin chrome

Door application chart

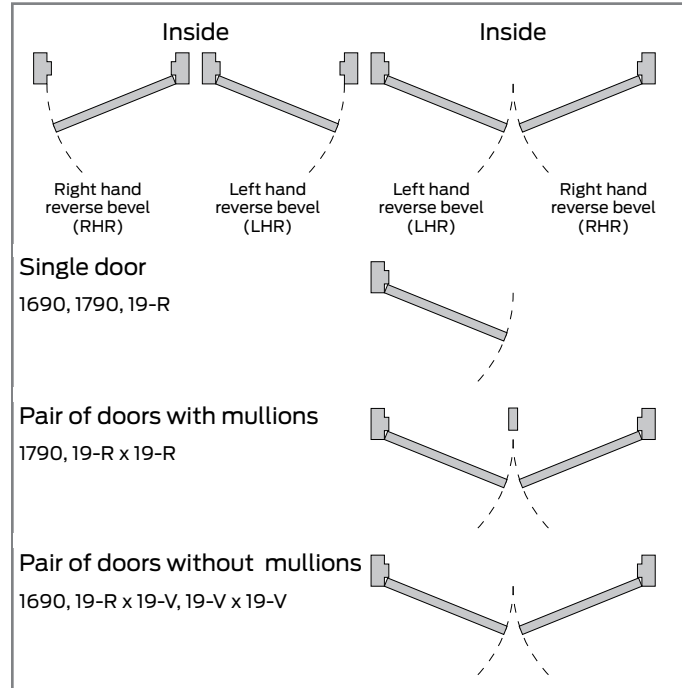

Device	Label	Door opening	Application
Hollow metal door			
F-19-R	1 1/2 hr. "B"	4' x 7'2" 8' x 7'2"	Single, pair, same egress w/ F-4023 mullion and KR-F-4023
F-19-V	1 1/2 hr. "B"	8' x 10'	Pair, double egress, same egress
F-19-V-LBR	1 1/2 hr. "B"	8' x 8'	Pair, double egress, same egress
Wood door			
F-19-V-LBR	20 min.	8' x 8'	Wood or comp., pair, double egress, same egress
F-19-R	1 1/2 hr. "B"	4' x 7'2" 8' x 7'2"	Single, pair, same egress w/ F-4023 mullion and KR-F-4023

19 Device dimensions:

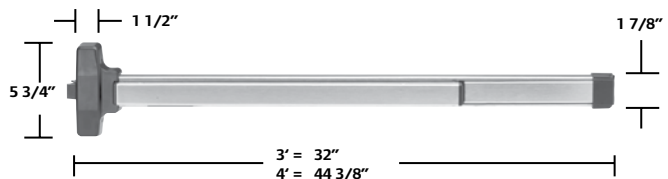

Strikes /accessories

Strikes

1690 Concealed vertical rod device



PB48
Top strike for 1690 device. Packed with three 0.050" thick shims. 1 1/16" x 1 1/16" x 7/16" (H x W x D)

1790 Rim device



STK45
Strike for inactive leaf, pair of doors with 1790 device. 3 1/4" x 1 5/16" x 1/4" (H x W x D)



TD35
Strike for single doors, 1790 device. Includes 1/8" shim. 3" x 2" x 1/2" (H x W x D)

(F) 19-R Rim devices



F570
Standard strike. 2 5/8" x 1 1/4" x 19/16" (H x W x D)



F490
Optional strike. 2 5/8" x 1 1/4" x 7/8" (H x W x D)



565
Adjustable surface mounted for use with blade or applied stops. Mounts flush for 1/2" stop height.



571/571A
Used on inactive leaf for device on active leaf of pair of doors without removable mullion. 571 keeps 2 5/16" backset. 571A is trimmer and projects less into opening.

(F) 19-V Surface vertical rod devices



3788
Top strike for 19-V.



2130
19-V bottom strike for grouting into concrete or masonry floors.



4155
19-V optional bottom strike.



2126A
19-V optional bottom strike.

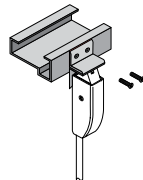

4215
Angle bracket for 19-V devices flush transom applications. Does not require elimination of latch retention feature.



Extension rods
Extension rods are available in 12", 24" and 36" lengths in all finishes. Both ends tapped and all-thread included as connector.

Popular EL application

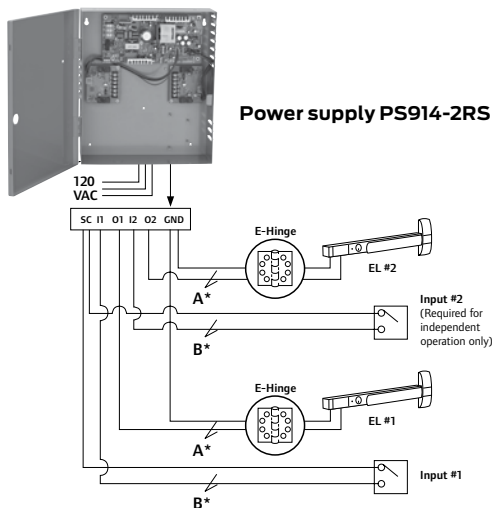

EL Device wire selection size

A*	Run length	EL device w/EPT or door loop
	0-100 ft.	14 gauge
	100-200 ft.	12 gauge

A*	Run length	EL device w/electric hinge/pivot
	0-75 ft.	14 gauge
	76-150 ft.	12 gauge

B*	Wire selection	Switch wire size
	1200 ft. max.	18 gauge

