

MLRK1-KAWP

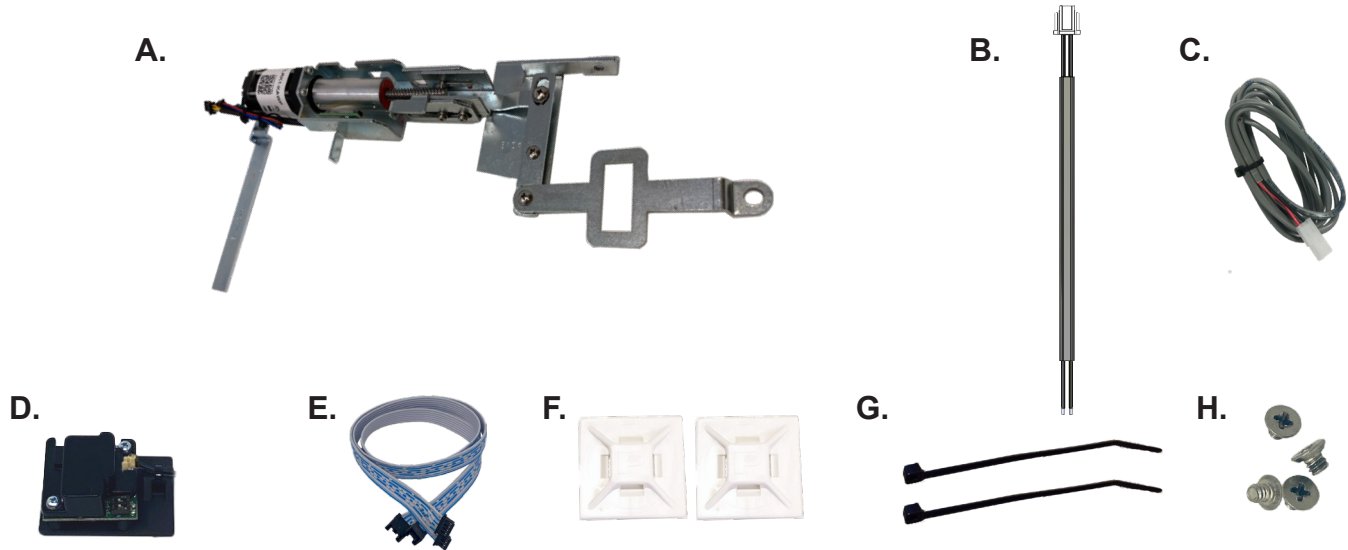

INSERT INSTRUCTIONS

The Command Access MLRK1-KAWP is a field-installable motorized latch-retraction kit for the Kawneer Paneline series exit devices.



KIT INCLUDES

- | | |
|-------------------------------------|------------------------------------|
| A. 60417 – MLRK1 MOTOR | E. 51198 – REMOTE MODULE CABLE |
| B. 50944 - MOLEX PIGTAIL | F. 40059 – (X2) CABLE MOUNTING PAD |
| C. 50030 – 6' POWER CABLE | G. 40060 – (X2) CABLE TIES |
| D. 60708/51186 – MM4T REMOTE MODULE | H. 40306 – PHILLIPS SCREWS (X4) |



INSTALLATION VIDEO

SPECIFICATIONS

- INPUT VOLTAGE: 24-25.3VDC
- AVERAGE LOW TORQUE LATCH RETRACTION CURRENT: 900 MA
- AVERAGE HIGH TORQUE LATCH RETRACTION CURRENT: 2A
- AVERAGE HOLDING CURRENT: 215 MA
- WIRE GAUGE: MINIMUM 18 GAUGE
- DIRECT WIRE RUN - NO RELAYS OR ACCESS CONTROL UNITS IN-BETWEEN POWER SUPPLY & MODULE

OPTIONAL BUILT-IN REX

- SPDT - RATED .5A @24V
- GREEN= COMMON (C)
- BLUE = NORMALLY OPEN (NO)
- GREY = NORMALLY CLOSED (NC)

REQUIRED COMMAND POWER SUPPLIES: [USE A PS210/220/440B](#)

ALL COMMAND ACCESS EXIT DEVICES & FIELD INSTALLABLE KITS HAVE BEEN THOROUGHLY CYCLE TESTED WITH COMMAND ACCESS POWER SUPPLIES AT OUR FACTORY. IF YOU PLAN ON USING A NON-COMMAND POWER SUPPLY IT MUST BE A FILTERED & REGULATED LINEAR POWER SUPPLY.

REMOVING AND DISASSEMBLING PUSH PAD INSTRUCTIONS

- 1 Using a flat screw driver or putty knife, gently pry at top and bottom on **Filler Plater** on each side of device until they come out



REMOVING AND DISASSEMBLING PUSH PAD INSTRUCTIONS

- 2** Once exposed remove (4) **Philips head mounting screws** and remove push pad from pocket in door



REMOVING AND DISASSEMBLING PUSH PAD INSTRUCTIONS

3

Remove (4) **Philips head screws** attaching **Push Pad** to chassis

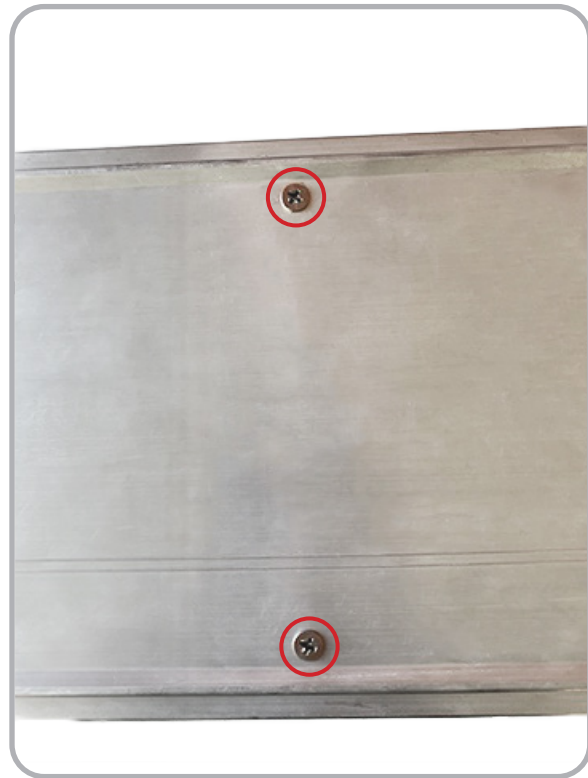
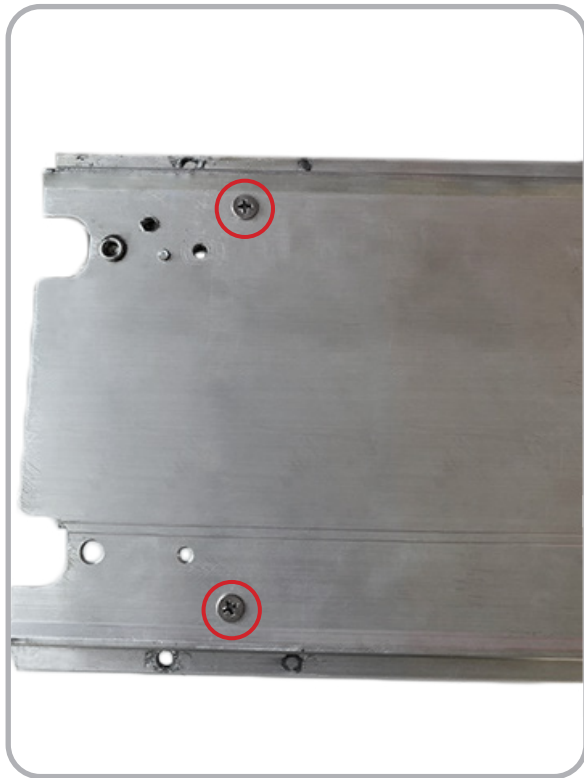
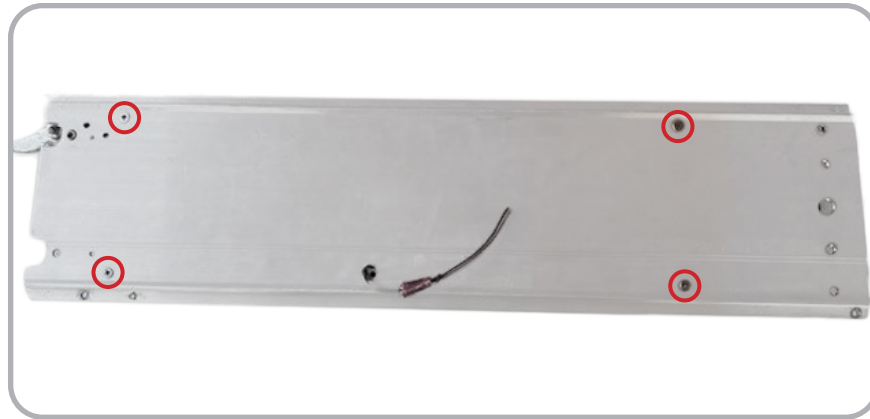

REMOVING AND DISASSEMBLING PUSH PAD INSTRUCTIONS

4

Disassemble **Retraction Assembly** (1) **Bolt** with (1) **C-Clip**, (2) **adjustment / set screws** and **“L” Piece**

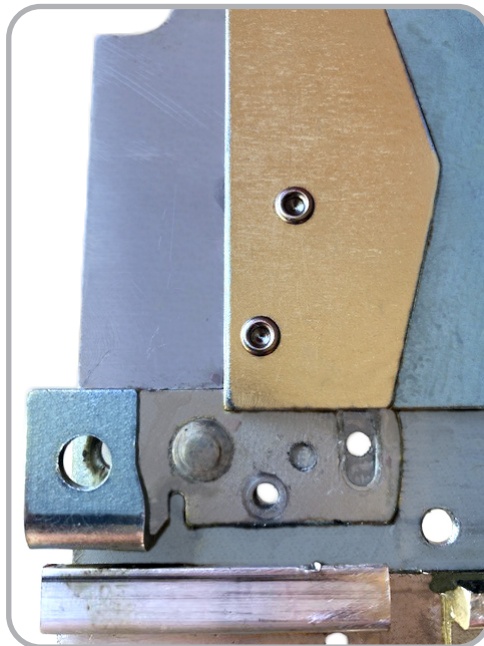
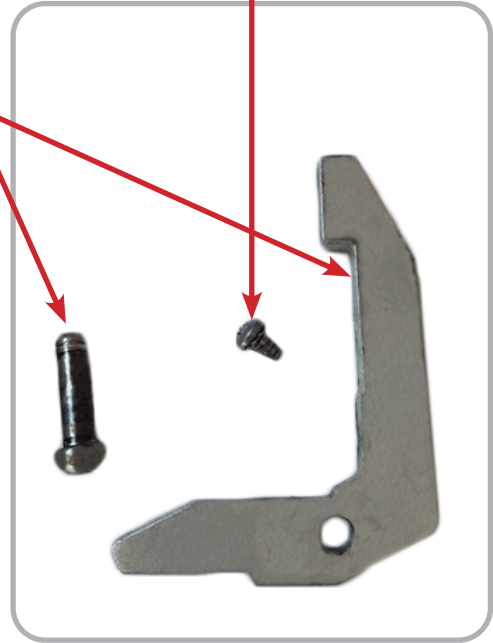

REMOVING AND DISASSEMBLING PUSH PAD INSTRUCTIONS

5 Remove **Push Pad** from chassis by pulling in opposite directions, if it proves difficult to separate, a rubber mallet can be used to get it past any stubborn points.

Watch for bearings that may fall out during removal.

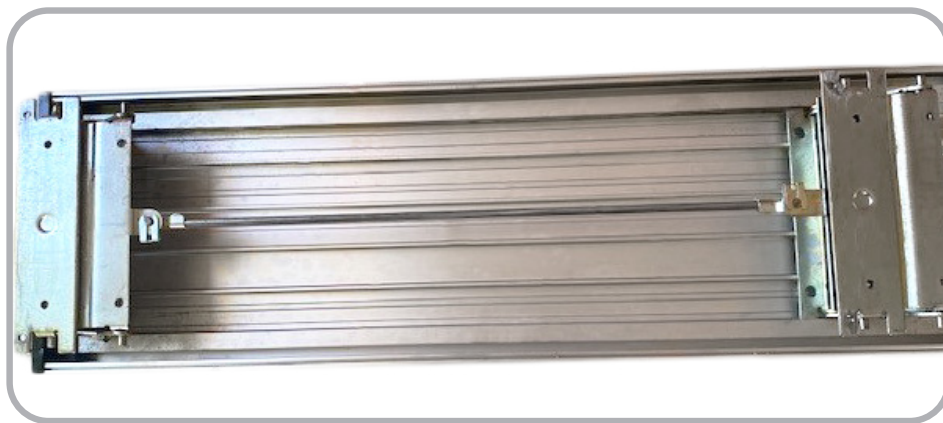
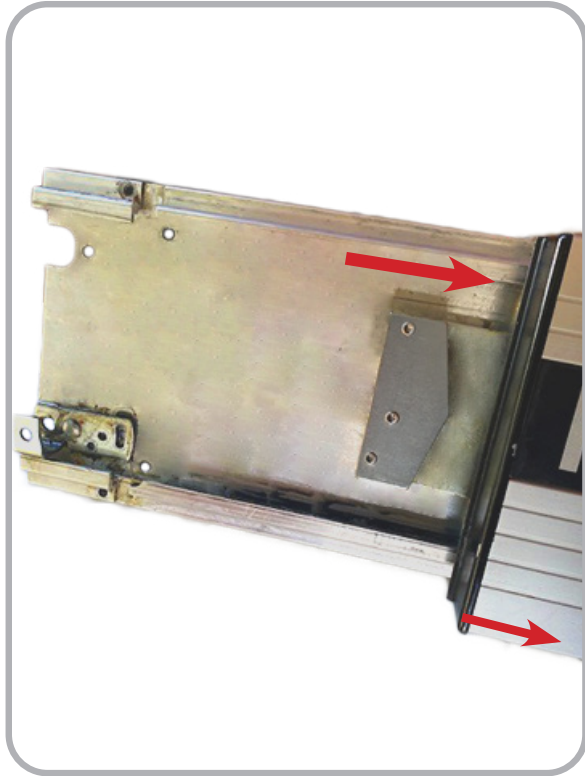

INSTALLATION INSTRUCTIONS

- 1** With the **Push Pad** removed, flip it over and locate the **Rear Activating Bracket**.

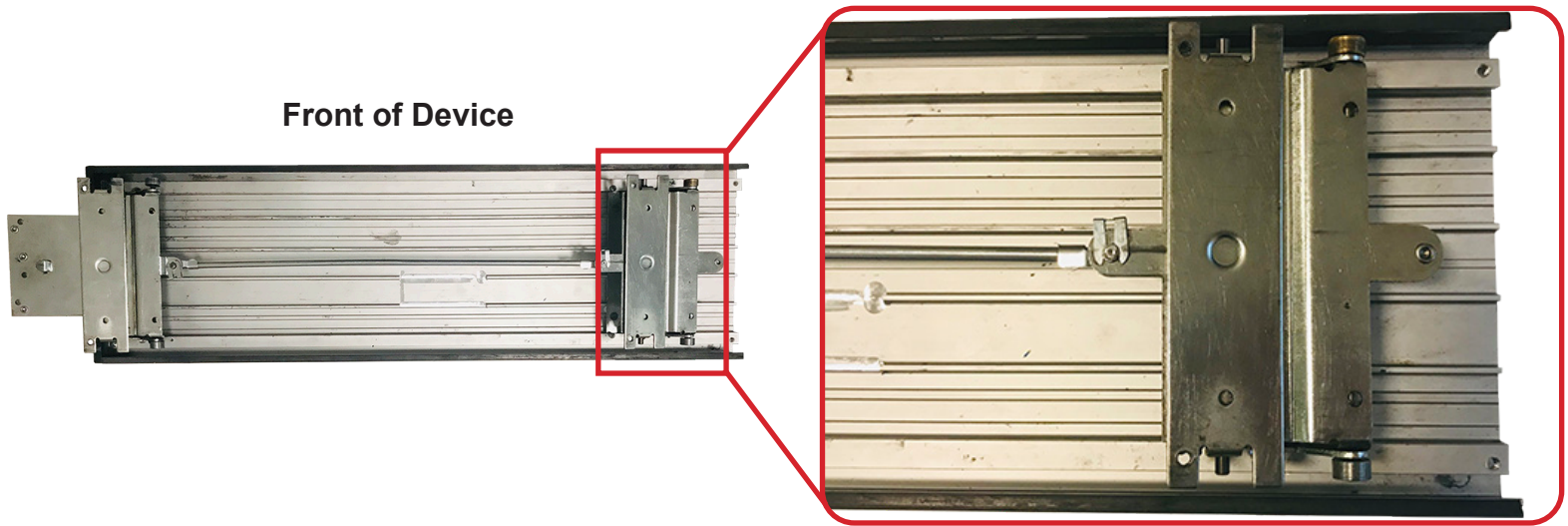

- 2** Locate the **Opening** in the **Rear Activating Bracket**, this is where the kits head link will slide through.



- 3** Flip the **Motor Kit** over so the underside is facing you, next slide the **Head Link** of the motor kit through the **Rear Activating Bracket Opening**.

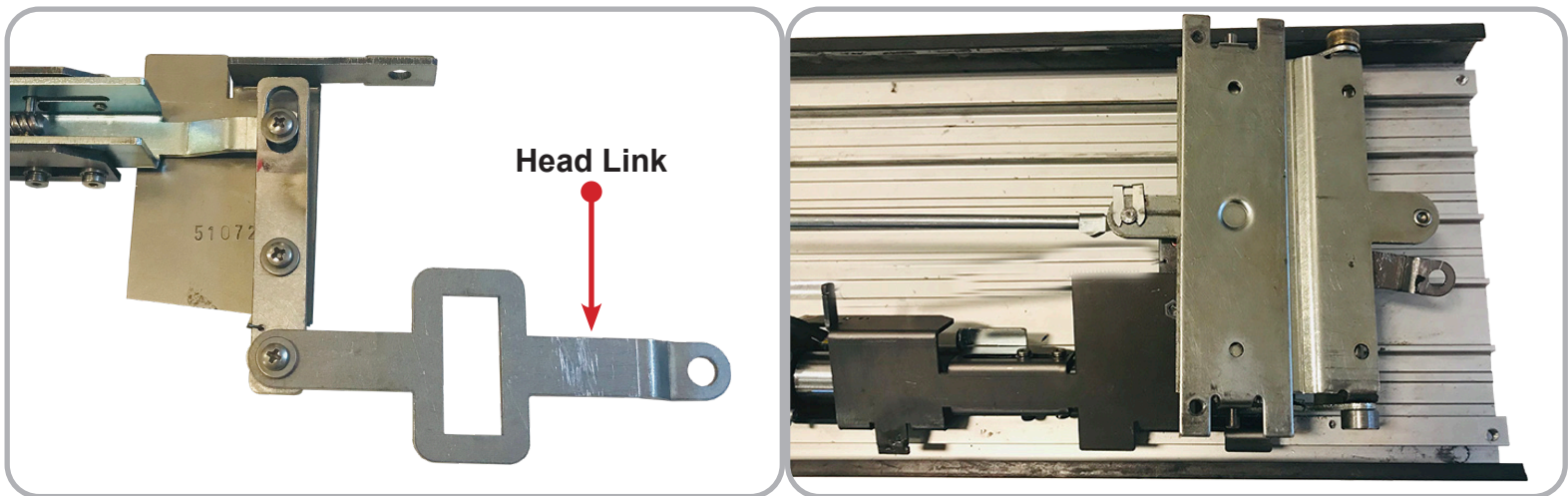

INSTALLATION INSTRUCTIONS

4 Fit the **Hole** on the end of the **Head Link** over the **Rear Post** of the **Rear Mounting Bracket** as shown.

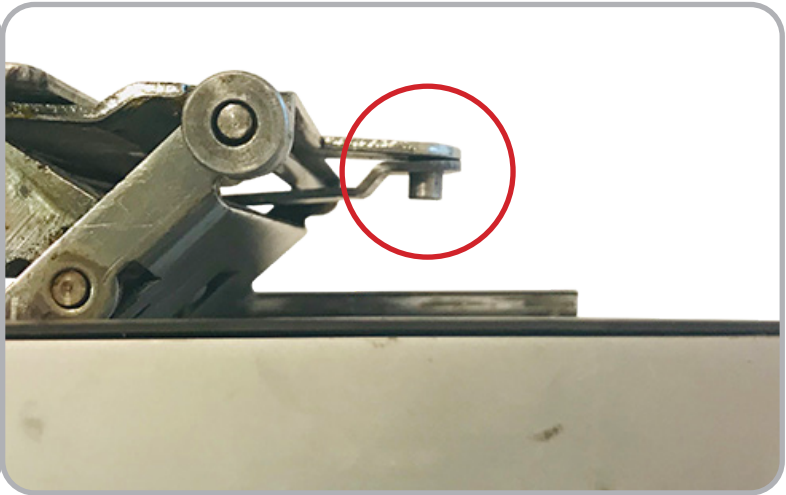
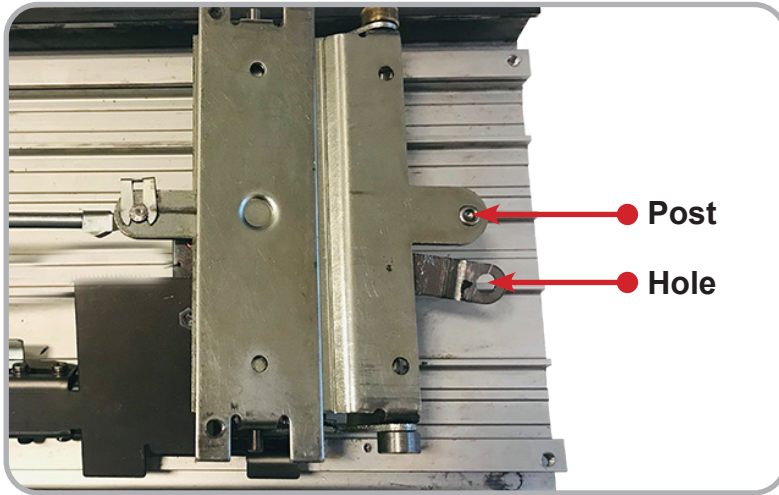

5 Then fit the **Hole** on the **Motor Bracket** over the **Side Post** of the **Rear Mounting Bracket** as shown.

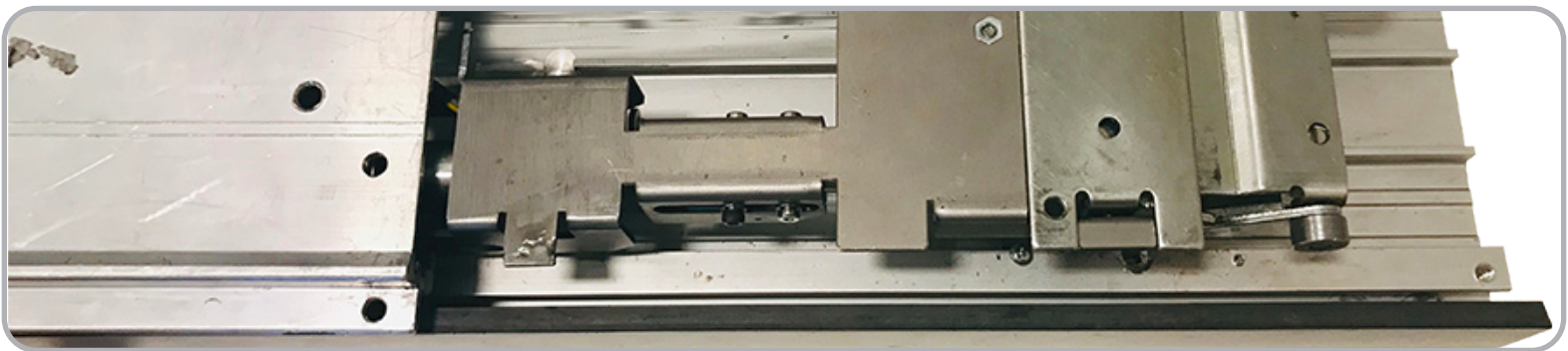
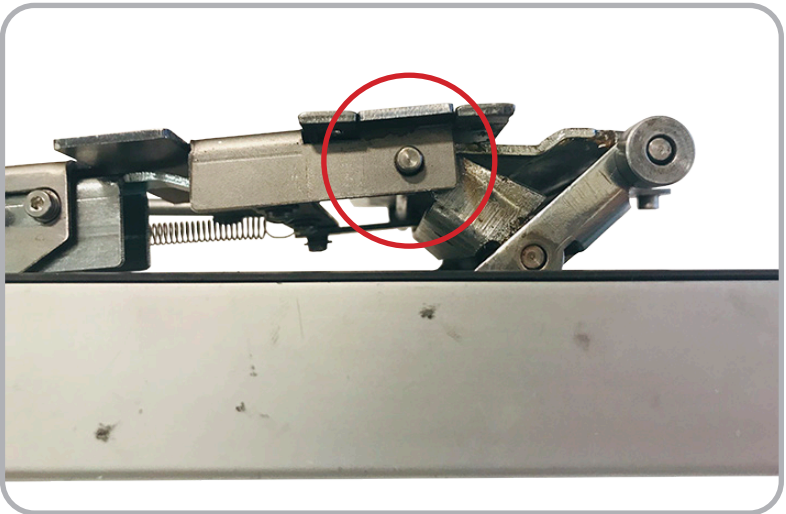
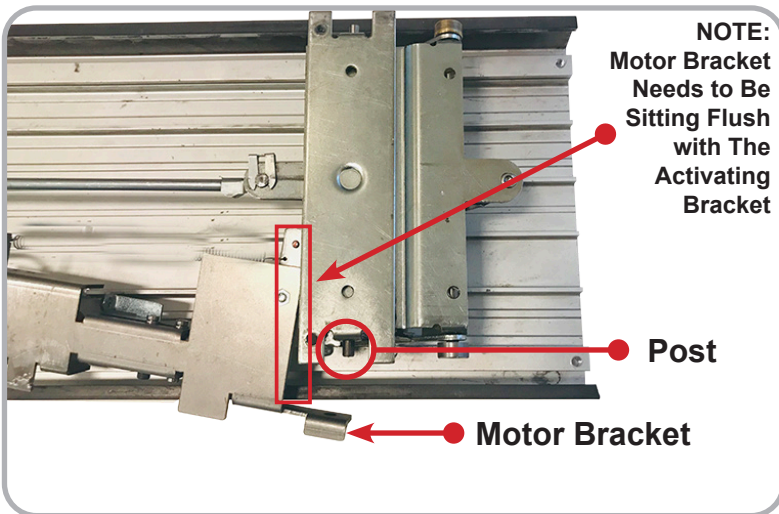

INSTALLATION INSTRUCTIONS

- 6** Once kit is in place connect **3-Pin** and **4 -Pin Connectors** on the **Remote Module Cable** to **3-pin** and **4-Pin Connectors** from **Motor** and **Sensor**. Apply **Strain Relief** as shown below or to installers best judgement.

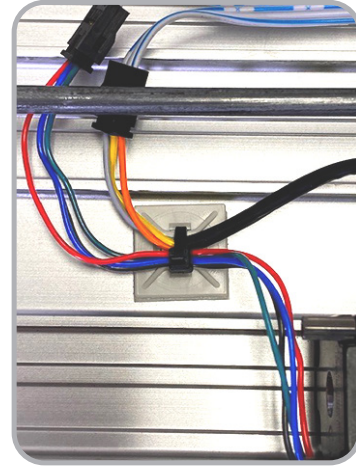
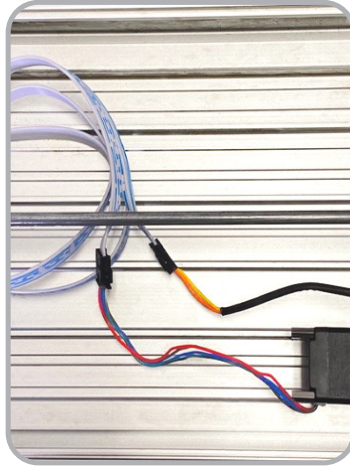
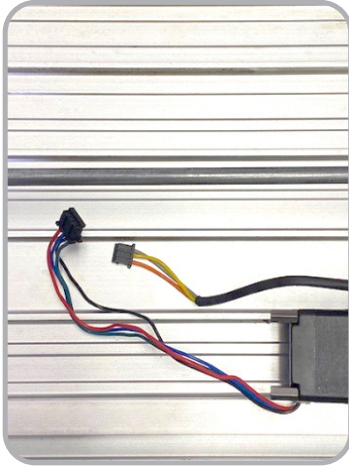

- 7** Guide wire to rear of device and feed through **Back Activating Bracket**. Ensure nothing is being pinched or strained by depressing the **Back Activating Bracket**.

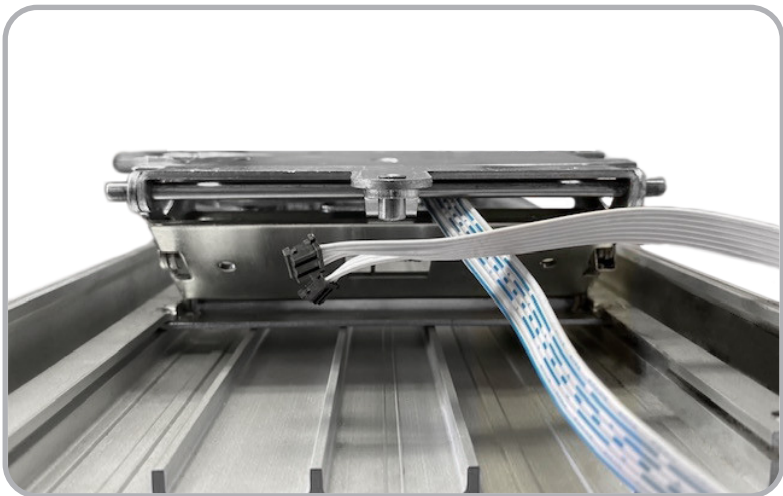
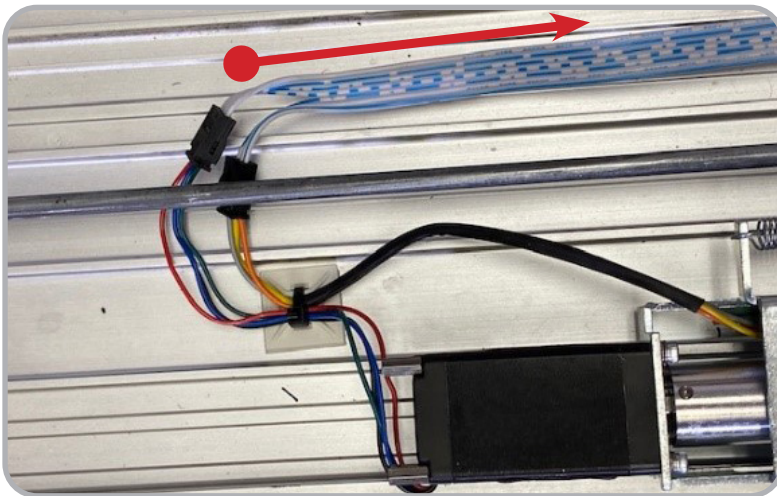

- 8** Before re-installing the **Push Pad**, ensure the bearings are still on the **Activating Brackets**!

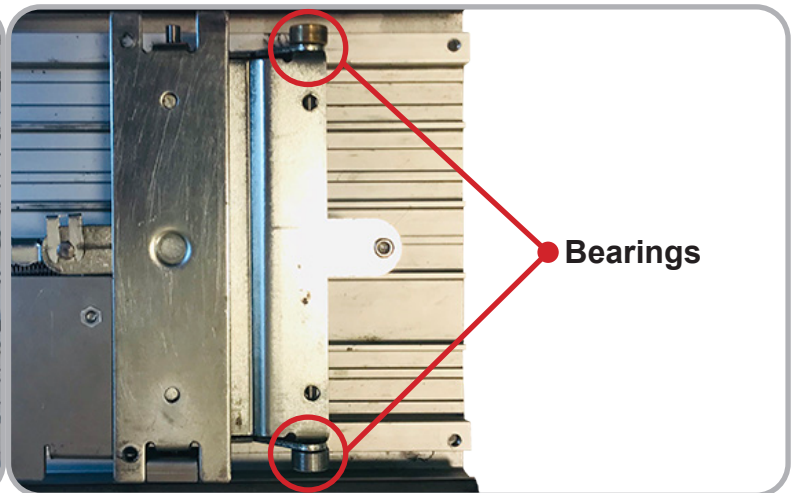
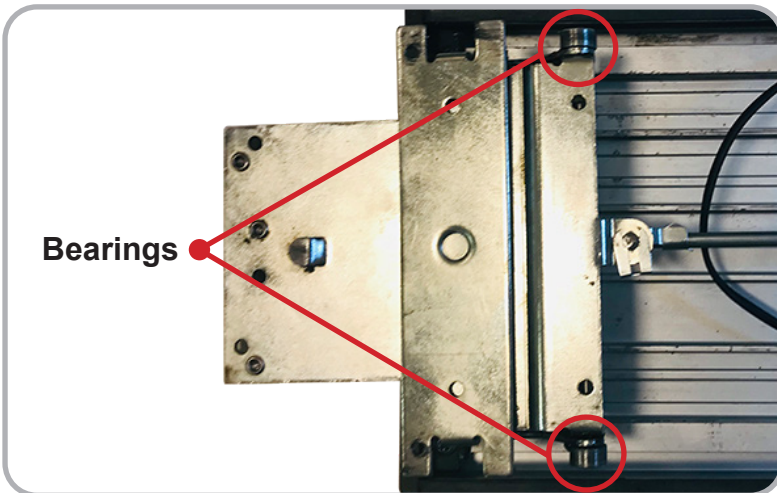

INSTALLATION INSTRUCTIONS

- 9** Re-install the **Base Rail**, making sure the **Front Activating Bracket** and **Bearings** slide into their **Slots**.

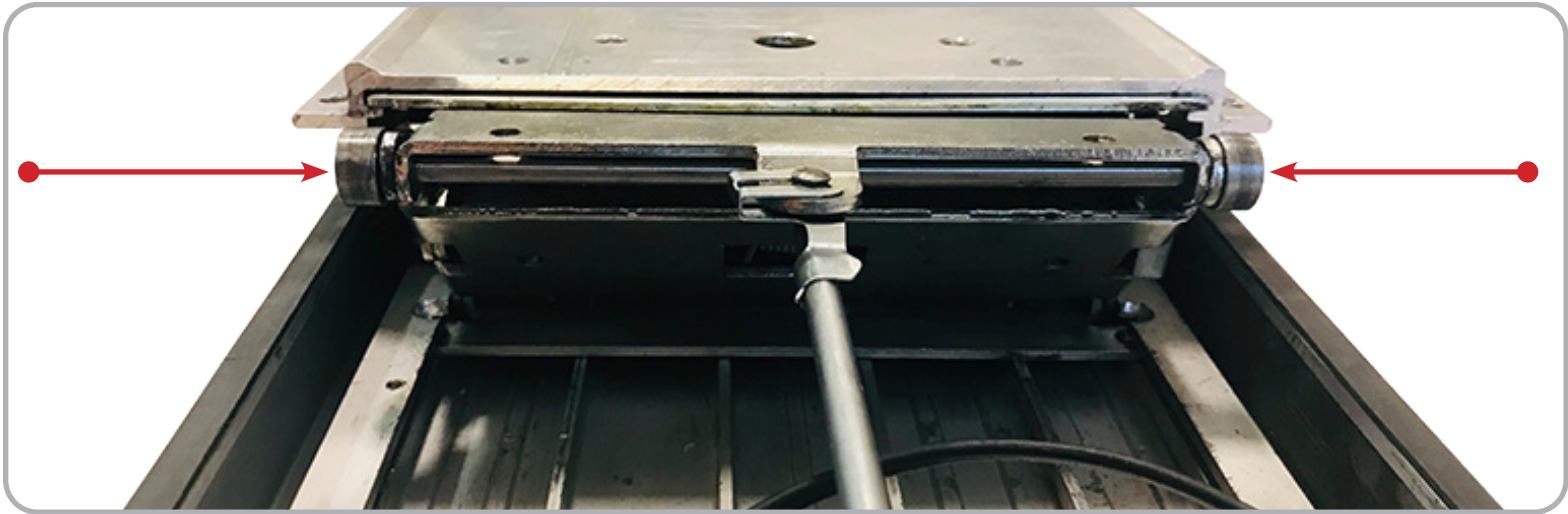

- 10** The **Two Tabs** on the **Motor Bracket**, **Rear Activating Bracket** and **Bearings** must also slide into the **Slots** on the **Base Rail**.

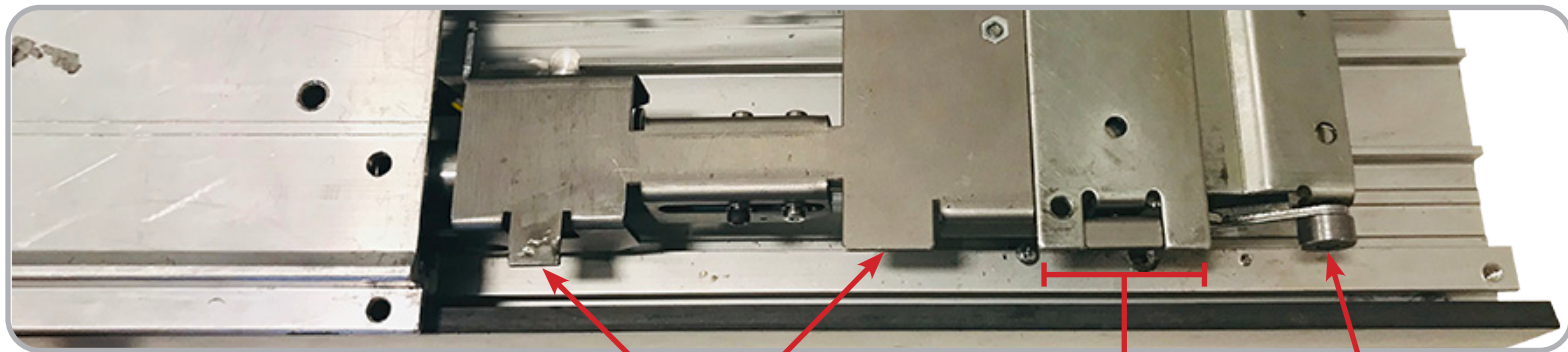

WARNING

If this bracket does not properly slide into channel, it will create a bind on the motor assembly

Motor Bracket Tabs

Activating Bracket

Bearings

INSTALLATION INSTRUCTIONS

- 11** Re-secure the **Baserrail** & re-mount the items that were removed in Step 4.

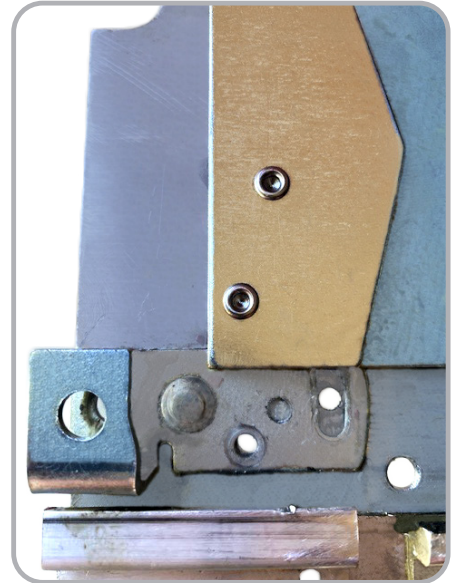

- 12** Re-install **Device** back into the door.



INSTALLATION INSTRUCTIONS

13

Connect **3-Pin** and **4-Pin Connectors** from **RM Cable** to **Remote MM4 Module**, mount **Module** in empty pocket using double sided tape. Hook incoming power to **2-Pin Connector** using provided power lead.

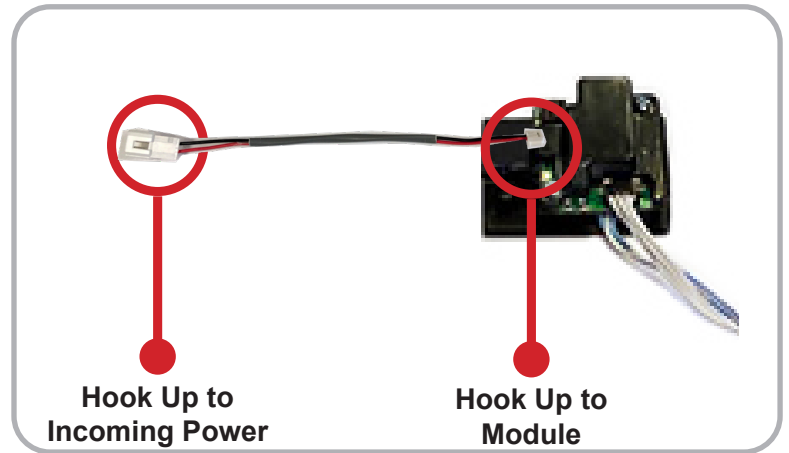
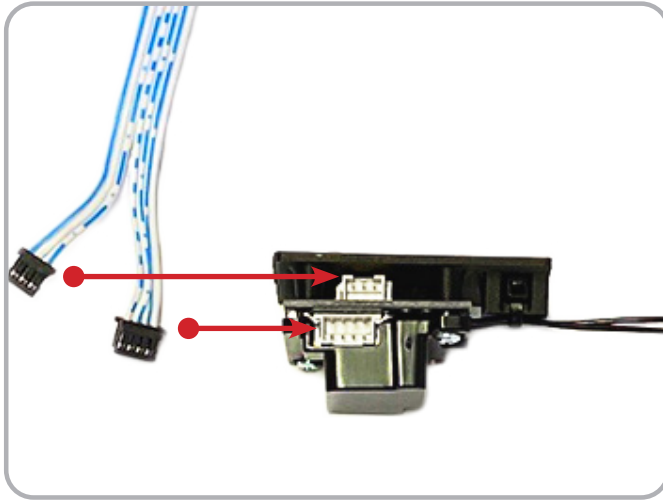

INSTALLATION INSTRUCTIONS

14

If mechanical adjustment of **Retaction Arm** is needed please follow instructions below

LIFT LEVER ADJUSTMENT

1. Lubricate lever as indicated.
2. Loosen the binder fastener on axle bracket.
3. Rotate the axle bracket until the lever arm contacts the bottom of the traveler roller. Tighten the binder fastener to allow for operation testing.
4. Stand the door up with a spacer between the door and the floor to allow for bolt operation and check for proper operation.
5. After testing unit thoroughly, drill a hole at location "A" using a #23 (0.154 dia.) drill bit.
6. Lock adjustment in place using extra binder fastener 028747.

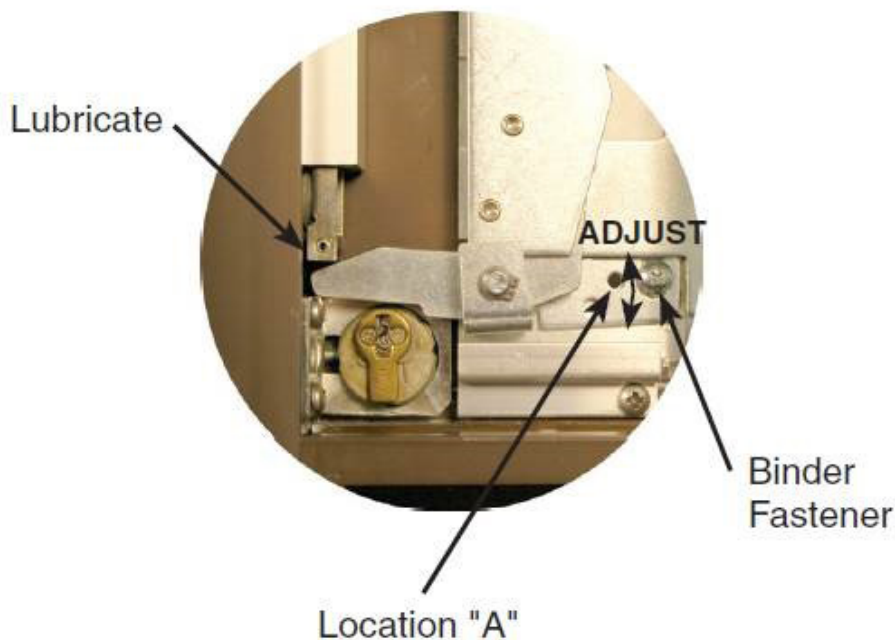

PUSH TO SET (PTS)



15

SETTING PUSH TO SET (PTS)

****IMPORTANT INFO****

MAKE SURE TO SET PTS BEFORE FINISHING INSTALLATION

- STEP 1** - Select your preferred torque mode (ships in standard torque). Press the device push pad to the desired setting. (We recommend to fully depress and release 5%, giving the device room for changing door conditions.)
- STEP 2** - While depressing the push pad, apply power.
- STEP 3** - Continue to keep the pad depressed, the device will beep 6 times. After the beeps have stopped, release the pad and the adjustment is now set. Test the adjustment 4 to 5 times and if not to your liking repeat the above steps.

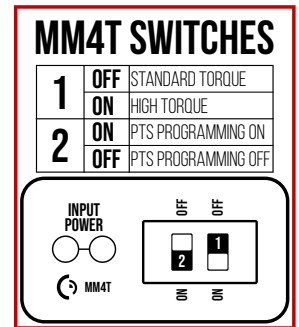

**Once you found your preferred adjustment, we recommend turning off the PTS programming switch.*

TROUBLESHOOTING & DIAGNOSTICS

BEEPS	EXPLANATION	SOLUTION
2 Beeps	Over Voltage	> 30V unit will shut down. Check voltage & adjust to 24 V.
3 Beeps	Under Voltage	< 20V unit will shut down. Check voltage & adjust to 24 V.
4 Beeps	Failed Sensor	Verify all 3 sensor wires are installed correctly. Replace sensor if problem persists by contacting office.
5 Beeps	Retraction or dogging failure	After 1st fail: 5 beeps then immediately attempts to retract again. After 2nd fail: 5 beeps with pause in-between for 30 seconds then device attempts to retract again. After 3rd fail: 5 beeps every 7 minutes, device will not attempt to retract. To Reset: Depress bar for 5 seconds at any time.
6 Beeps	PUSH TO SET	Device is recording it's new position and power mode after the 6th beep.

**TRIM POT ADJUSTMENT ONLY REQUIRED WHEN PTS PROGRAMMING IS NOT SETTING TO THE CORRECT LOCATION*



***Latch bolt adjustment-** If the latch bolt is not retracting far enough, turn the dial clockwise with a small flat blade screw driver. If the latch bolt is retracting too far causing the device to chatter and drop-out, turn the dial counter-clockwise until the chatter and drop-outs stop and the desired location is achieved.